

Crawler Crane Grue sur chenilles

LR 1400/2

Technical Data Caractéristiques techniques

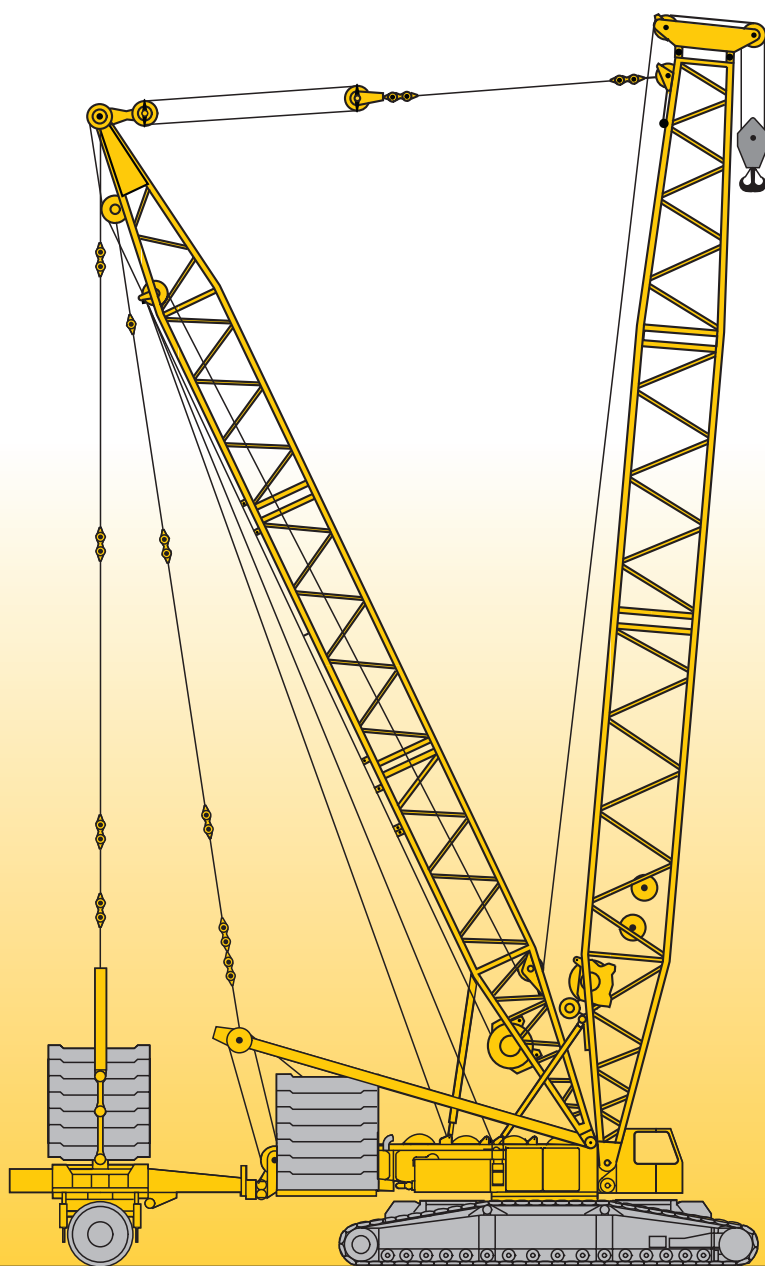

LIEBHERR

Table of content

Tables des matières

Table of content

Technical description, crawler track chassis, crane superstructure, boom configurations and optional features	3 – 5
Dimensions and working speeds	6 – 10
Hook blocks and hooks, reeving chart	11
Transportation plan	12 – 14
Boom/jib combinations	15 – 17
Lifting capacities and heights on L/LL/LD/LDB/BW boom/derrick combination	18 – 24
Lifting capacities and heights on LF boom/jib combination	25 – 30
Lifting capacities and heights on LN boom/jib combination	31 – 35
Lifting capacities and heights on SL/SLD/SLDB/BW boom/derrick combination	36 – 41
Lifting capacities and heights on SLN boom/jib combination	42 – 46
Lifting capacities and heights on S boom	47 – 48
Lifting capacities and heights on Sw/SwD/SwDB/BW boom/derrick combination	49 – 53
Lifting capacities and heights on SD/SDB/BW boom/derrick combination	54 – 56
Lifting capacities and heights on SW boom/jib combination	57 – 59
Lifting capacities and heights on SDWB/BW boom/jib combination	60 – 67

Tables des matières

Description technique, châssis à chenilles, partie tournante, les configurations de flèches et les équipements complémentaires	3 – 5
Les dimensions et les vitesses	6 – 10
Organes de préhension et tableau de mouflage	11
Plan de transport	12 – 14
Les configurations de flèche	15 – 17
Les forces de levage et hauteurs de levage L/LL/LD/LDB/BW en configuration	18 – 24
Les forces de levage et hauteurs de levage en configuration LF	25 – 30
Les forces de levage et hauteurs de levage en configuration LN	31 – 35
Les forces de levage et hauteurs de levage en configuration SL/SLD/SLDB/BW	36 – 41
Les forces de levage et hauteurs de levage en configuration SLN	42 – 46
Les forces de levage et hauteurs de levage à la flèche principale S	47 – 48
Les forces de levage et hauteurs de levage en configuration Sw/SwD/SwDB/BW	49 – 53
Les forces de levage et hauteurs de levage en configuration SD/SDB/BW	54 – 56
Les forces de levage et hauteurs de levage en configuration SW	57 – 59
Les forces de levage et hauteurs de levage en configuration SDWB/BW	60 – 67

Technical description

Description techniques

Crawler travel gear

Frame	Self-manufactured, torsion-resistant box-type design of high-tensile grain refined steel, comprising crawler centre section and two crawler carriers. The crawler carriers are pinned hydraulically.
Travel gear	Maintenance-free, dirt-protected crawler travel gear with 3'11" (4'11" optional) track pads and centralized lubrication system for tumbler and track roller bearings.
Travel drive	1 (optionally 2) hydraulic drives per crawler carrier, comprising axial piston variable displacement motor, planetary gear with spring-loaded, hydraulically releasable travel brake and tumbler. The crawler chains are controllable synchronously, independently and opposed to one another.
Central ballast	94800 lbs, consisting of 2 slabs 12130 lbs each and 4 slabs 17640 lbs each.

Crane superstructure

Frame	Self-manufactured, torsion resistant weldment of high-tensile grain refined steel. Connected to crawler travel gear by a 3-row roller slewing rim for 360° continuous rotation.
Crane engine	6-cylinder Diesel engine, make Liebherr, type D936L A6, watercooled, 270 kW (367 HP) at 1900 rpm, max. torque 1269 lbs-ft at 1300 rpm. Exhaust emissions acc. to 97/68/EG stage 3 and EPA/CARB Tier 3. Electronic engine management. Fuel tank: 185 gallons.
Crane drive	Diesel-hydraulic by pump distribution gear with 4 axial piston variable displacement pumps with capacity control within closed oil circuits.
Crane control	Servo-control with electronic synchronizing device by three four-way control levers and two two-way control levers (joy-stick type). Continuous control of the crane motions by variation of the hydraulic pumps, additionally by variation of the Diesel engine speed.
Winches 2 and 4	Hydraulically driven cable drums by axial piston variable displacement motor and planetary gear with spring-loaded, hydraulically releasable static brake. Wearfree braking function during lowering by closed oil circuits. Winch 2 – hoist gear, winch 4 – derrick gear. Auxiliary winch for reeving of cables.
Slewing gear	2 slewing gears (optionally 4), hydraulically powered by axial piston variable displacement motor and planetary gear with spring-loaded, hydraulically releasable static brake. Wearfree braking function by closed oil circuits.
Crane cabin	Spacious, all-steel construction cabin, swivelling sideways and tiltable backwards, with operating and control instruments. Self-contained warm-water heating (optionally air-conditioning system).

Safety devices	LICCON safe load indicator, hoist limit switches, electronic inclinometer, safety valves for the prevention of pipe and hose ruptures, anemometer.
Electrical system	24 V DC, 2 batteries of 170 Ah each.
Superstructure ballast	Max. 341750 lbs.

Boom system

Light version

L – main boom	L 69 ft – 344 ft (L 344 ft only with derrick), system 2620.10 / 2620.8. Base section 44'. Intermediate sections 23' and 46', boom head adapter 23', 550 kips (optional 770 kips) head section 2', safety retaining ram.
LL – main boom	LL 161 ft – 344 ft, system 2620.10 / 2115.10. Base section 44', intermediate sections 23' and 46', LL-reducing section 9'10", head adapter 11'6", 286 kips head section 26'3", safety retaining ram.
D – derrick boom	D 92 ft, system 2125.20, base section 34'5", intermediate section 23', head section 34', derricking block, safety retaining ram.
N – jib	N 69 ft – 299 ft, system 2115.10 / 1812.10, base section 31'2", intermediate sections 23' and 46', reducing section 11'6", 286 kips head section 26'3", retaining device, NA-frames 1 and 2.
F – fixed jib	F 34 ft – 126 ft, system 1812.10. Base section 31'2", intermediate sections 23' and 46', reducing section 11'6", 286 kips head section 26'3", retaining device, FA-frame.

Heavy version

SL – main boom	SL 69 ft 367 ft (SL 322 ft – 367 ft only with derrick), system 2620.20 / 2620.10, base section 44', intermediate sections 23' and 46', head adapter 23', 550 kips (optional 770 kips), head section 2', safety retaining ram.
S – main boom	S 69 ft – 390 ft (S 299 ft – 390 ft only with derrick), system 2620.20, base section 44', intermediate sections 23' and 46', head adapter 23', 550 kips (optional 770 kips), head section 2', safety retaining ram.
Sw – main boom	Sw 92 ft – 367 ft (Sw 344 ft – 367 ft only with derrick), system 2620.20 / 2116.20, base section 44', intermediate sections 23' and 46', reducing section 13'5", 396 kips head section 34'5", safety retaining ram.
W – luffing fly jib	W 92 ft – 299 ft, system 2116.20, base section 34', intermediate sections 23' and 46', 396 kips head section 34', retaining device, WA-frames 1 and 2.
B – suspended ballast	Suspended ballast pallet with compensating rams and hydraulic telescopic guiding device for max. 573000 lbs derrick ballast at max. 49'3" counter-radius.
BW – ballast trailer	Ballast trailer with compensating rams and hydraulic telescopic guiding device for max. 573000 lbs derrick ballast at max. 49'3" counter-radius.

Technical description Description techniques

Optional equipment

Winches 1, 3, 5 and 6	Winch 1 – hoist gear, winch 3-luffing main boom/D-mode, winch 5 – variation of luffing fly jib, winch 6-additional hoist gear.
Ballast	Suspended ballast B 550000 lbs, 25 slabs of 22000 lbs each for a total of 573000 lbs derrick ballast. Ballast trailer BW 507000 lbs, 23 slabs of 22050 lbs each for a total of 573000 lbs derrick ballast.
Mechanical additional support	For the erection of long boom configurations without derrick ballast.
Hydraulic mounting supports	For raising the basic machine during assembly/disassembly.
Mounting rams crawler carriers	For self-assembly/disassembly of the crawler carriers by the crane.
Portable pin pulling device	For the assembly/disassembly of the pins of the crawler travel gear and the boom pin intermediate sections.
Quick Connection	Rapid coupling system to facilitate separation of the superstructure from the crawler travel gear.
Whip line	Whip line 79400 lbs to be fitted to L-, N-, S-, W-head. Whip line 132200 lbs to be fitted to L-, S- and W-head.

Further equipment items on request.

Train de chenilles

Châssis	Fabrication Liebherr, structure caissonnée indéformable, en acier à grains fins à haute résistance, composé d'une partie centrale sur chenilles et de deux longerons. Les longerons sont fixés hydrauliquement par des axes.
Train de roulement	Train de chenilles exempt d'entretien et protégé de toute impureté. Largeur des tuiles: 3'11" (4'11" en option); dispositif de graissage centralisé pour les paliers du barbotin et des galets de roulement.
Entraînement	1 (2 en option) transmission(s) hydraulique(s) par longeron, avec moteur à cylindrée variable à pistons axiaux, réducteur à planétaires avec frein de translation à ressort et à ventilation hydraulique et barbotin. Les chenilles sont dirigeables de manière indépendante et en contre-rotation.
Contrepoids central	94800 lbs, composé de 2 plaques de 12130 lbs et 4 plaques de 17640 lbs.

Partie tournante

Châssis	Fabrication Liebherr, structure caissonnée indéformable en acier à grains fins à haute résistance. Couronne d'orientation à triple rangées de rouleaux entre partie tournante et châssis porteur, orientable à 360°.
Moteur	Diesel, 6 cylindres, marque Liebherr, type D936L A6, refroidi par eau, puissance 270 kW (367 ch) à 1900 rpm, couple max. 1269 lbs-ft à 1300 rpm. Emissions des gaz d'échappement conformes aux directives 97/68/EG partie 3 et EPA/CARB Tier 3. Gestion électronique. Réservoir à carburant: 185 gallons.
Entraînement de la grue	Hydraulique diesel via mécanisme de distribution des pompes, avec 4 pompes à débit variable à pistons axiaux et régulation de puissance, circuits hydrauliques fermés.
Commande de la grue	Servocommande avec dispositif électronique de synchronisation via trois manipulateurs en croix à quadruple fonction et deux manipulateurs à double fonction. Régulation continue de tous les mouvements de la grue par régulation des pompes hydrauliques et régulation du régime du moteur diesel.
Treuil 2 et 4	Tambour entraîné hydrauliquement via le moteur à cylindrée variable à pistons axiaux et le réducteur à planétaires avec frein d'arrêt à ressort et à ventilation hydraulique. Freins exempts d'usure lors du processus d'abaissement via les circuits hydrauliques fermés. Treuil 2 – mécanisme de levage, treuil 4 – treuil de relevage. Treuil auxiliaire pour le mouflage des câbles.
Mécanisme d'orientation	2 mécanismes d'orientation (4 en option), entraîné hydrauliquement par le moteur à cylindrée variable à pistons axiaux et le réducteur à planétaires avec frein d'arrêt à ressort et à ventilation hydraulique. Freins exempts d'usure via le circuit hydraulique fermé.
Cabine du grutier	Cabine spacieuse en tôle électrozinguée, orientable latéralement et inclinable vers l'arrière, avec instruments de commande et de contrôle et chauffage à eau chaude indépendant du moteur (climatisation en option).
Dispositifs de sécurité	Contrôleur de charge LICCON, fin de course de levage, indicateur d'angle d'inclinaison, clapets de sécurité sur tuyaux et flexibles contre rupture, anémomètre.
Circuit électrique	24 V en courant continu, 2 batteries de 170 Ah.
Contrepoids de la partie tournante	Max. 341750 lbs.

Technical description Description techniques

Système de flèche

Exécution légère

Flèche principale L	L 69 ft – 344 ft (L 344 ft uniquement avec Derrick), système 2620.10 / 2620.8. Élément de base de 44', éléments intermédiaires de 23' et 46', adaptateur de tête de 23', élément de tête de 2' de 550 kips (770 kips en option), vérin anti-retour.
Flèche principale LL	LL 161 ft – 344 ft, système 2620.10 / 2115.10. Élément de base de 44', éléments intermédiaires de 23' et 46', réducteur LL de 9'10", adaptateur de tête de 11'6", élément de tête de 26'3" de 286 kips, vérin anti-retour.
Flèche Derrick D	D 92 ft, système 2125.20. Élément de base de 34'5", élément intermédiaire de 23', élément de tête de 34', palonnier de renvoi, vérin anti-retour.
Flèche relevable N	N 69 ft – 299 ft, système 2115.10 / 1812.10. Élément de base de 31'2", éléments intermédiaires de 23' et 46', réducteur de 11'6", élément de tête de 26'3" de 286 kips, dispositif anti-retour, chevalet NA 1 et 2.
Fléchette fixe F	F 34 ft – 126 ft, système 1812.10. Élément de base de 31'2", éléments intermédiaires de 23' et 46', réducteur de 11'6", élément de tête de 26'3" de 286 kips, dispositif anti-retour, chevalet FA.

Exécution lourde

Flèche principale SL	SL 69 ft – 367 ft (SL 322 ft – 367 ft uniquement avec Derrick), système 2620.20 / 2620.10, élément de base de 44', éléments intermédiaires de 23' et 46', adaptateur de tête de 23', élément de tête de 2' de 550 kips (770 kips en option), vérin anti-retour.
Flèche principale S	S 69 ft – 390 ft (S 299 ft – 390 ft uniquement avec Derrick), système 2620.20, élément de base de 44', éléments intermédiaires de 23' et 46', adaptateur de tête de 23', élément de tête de 2' de 550 kips (770 kips en option), vérin anti-retour.
Flèche principale Sw	Sw 92 ft – 367 ft (Sw 344 ft – 367 ft uniquement avec Derrick), système 2620.20 / 2116.20, élément de base de 44', éléments intermédiaires de 23' et 46', réducteur de 13'5", élément de tête de 34'5" de 396 kips, vérin anti-retour.
Fléchette à treillis a volée variable W	W 92 ft – 299 ft, système 2116.20, élément de base de 34'5", éléments intermédiaires de 23' et 46', élément de tête de 34' de 396 kips, dispositif anti-retour, chevalet WA 1 et 2.
Contrepoids suspendu B	Contrepoids suspendu avec vérin de guidage et guidage à télescopage hydraulique pour un contrepoids Derrick de max. 573000 lbs et pour une contre-portée de 49'3" max..
Remorque à contrepoids BW	Remorque à contrepoids avec vérin de guidage et guidage à télescopage hydraulique pour un contrepoids Derrick de max. 573000 lbs et pour une contre-portée de 49'3" max..

Équipement supplémentaires

Treuil 1, 3, 5 et 6	Treuil 1 – treuil de levage, treuil 3 – réglage flèche principale / mode D, treuil 5 – réglage fléchette à treillis à volée variable, treuil 6 – treuil de levage supplémentaire.
Contrepoids	Contrepoids suspendu B 550000 lbs, 25 plaques de 22050 lbs pour un contrepoids Derrick total de 573000 lbs. Remorque à contrepoids BW 507000 lbs, 23 plaques de 22050 lbs pour un contrepoids Derrick total de 573000 lbs.
Stabilisateur mécanique supplémentaire	Pour le relevage des longues combinaisons de flèches sans contrepoids Derrick.
Stabilisateur de montage hydraulique	Pour le levage de la machine de base lors du montage/démontage.
Vérin de montage longerons	Pour le montage/démontage autonome des longerons avec la grue.
Extracteur d'axes mobile	Pour le montage/démontage des axes du train de chenilles et de l'élément central ainsi que celui de la flèche – des éléments intermédiaires.
Raccord rapide	Pour une séparation aisée de la partie tournante et du train de chenilles.
Poulie brin simple	Poulie brin simple de 79400 lbs pour le montage sur tête L, N, S, et W. Poulie brin simple de 132200 lbs pour le montage sur tête L, S et W.

D'autres équipements supplémentaires sur demande.

Dimensions Encombrement

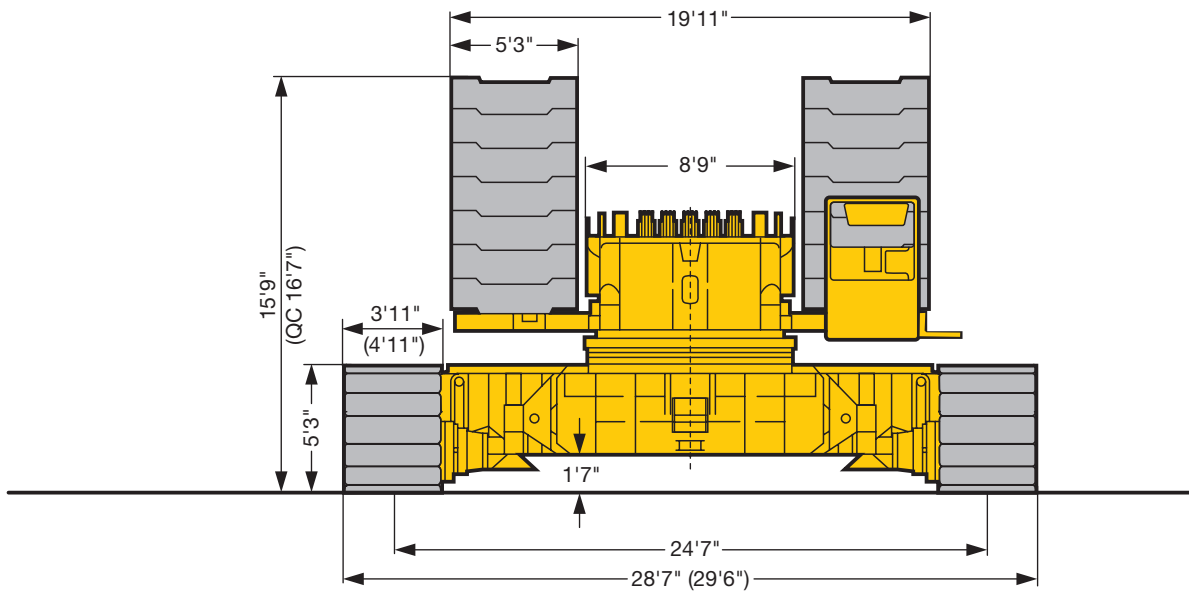
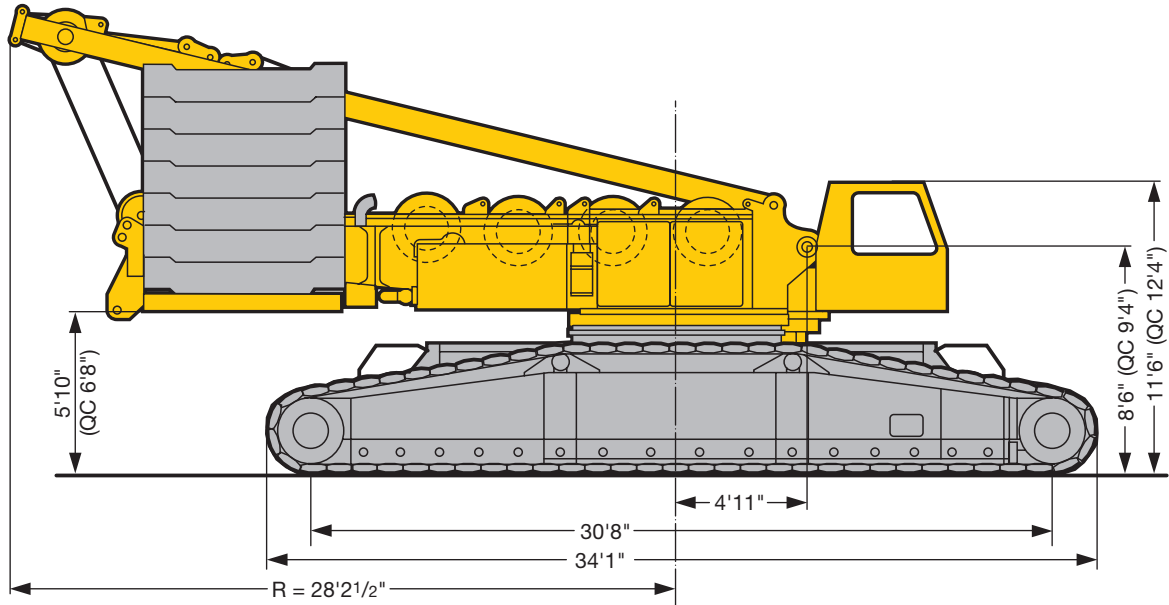

S1526

() Pad width 4'11" / Largeur de patin 4'11"

QC = Quick connection

Dimensions Encombrement

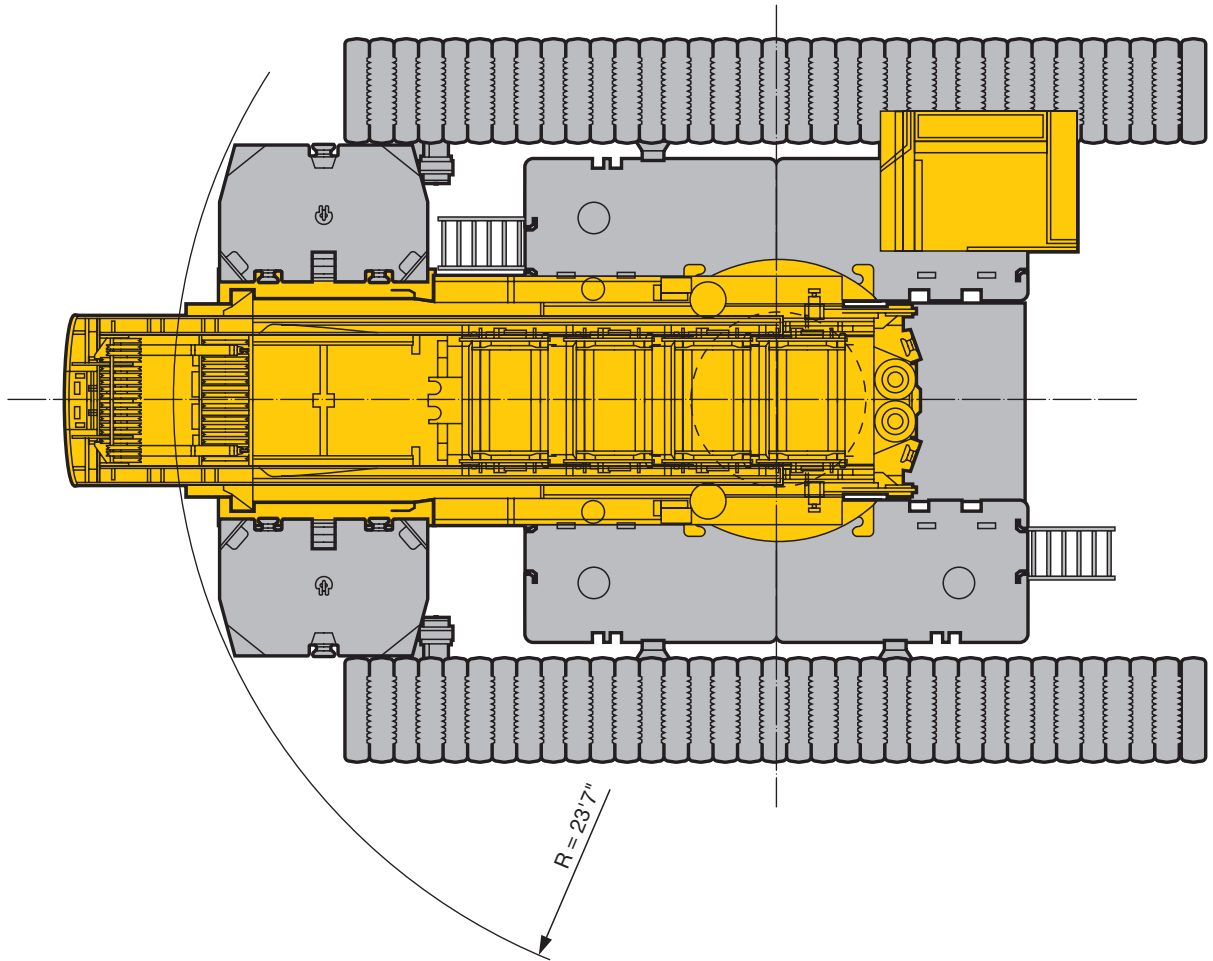

S1527

Dimensions Encombrement

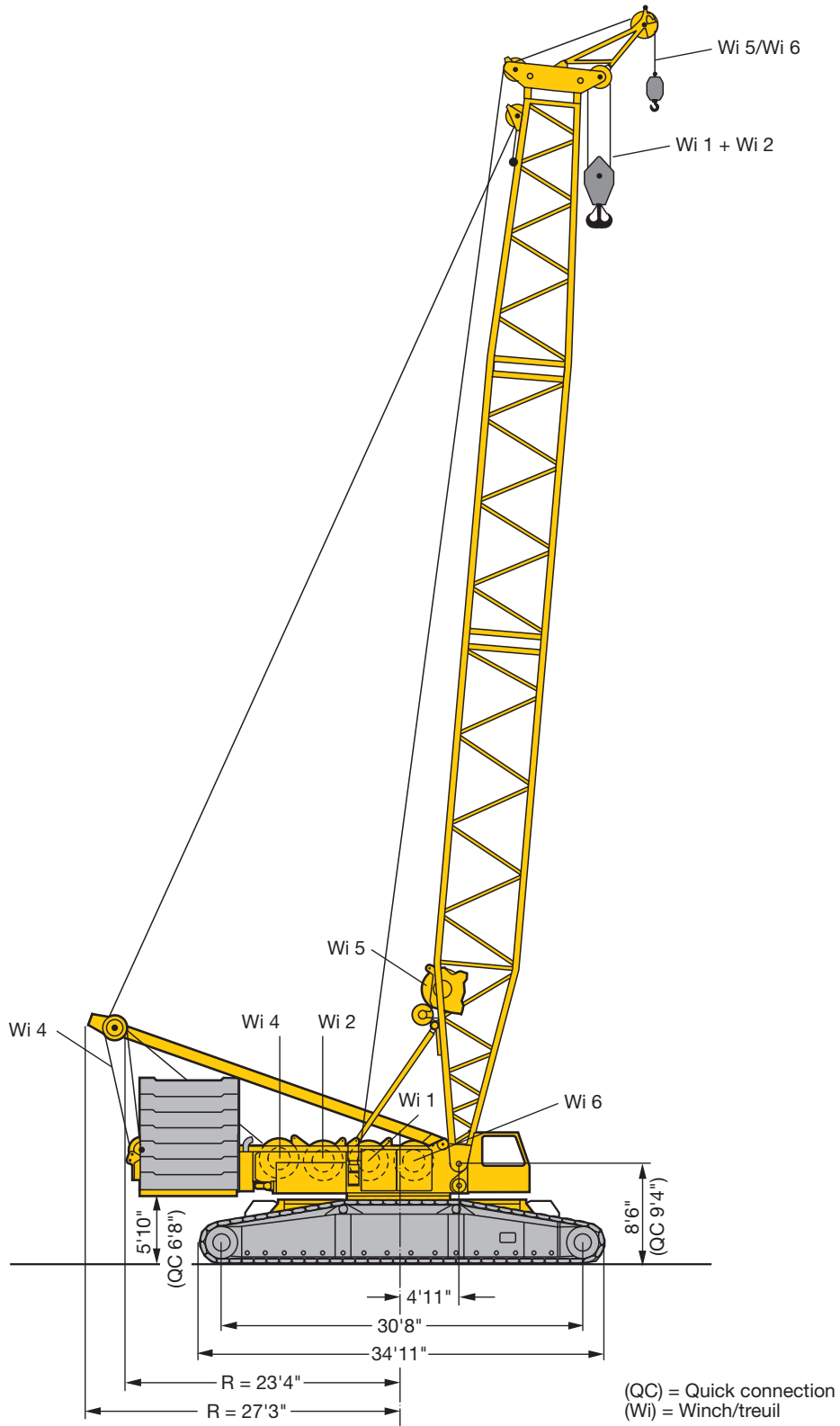

S1528

Dimensions Encombrement

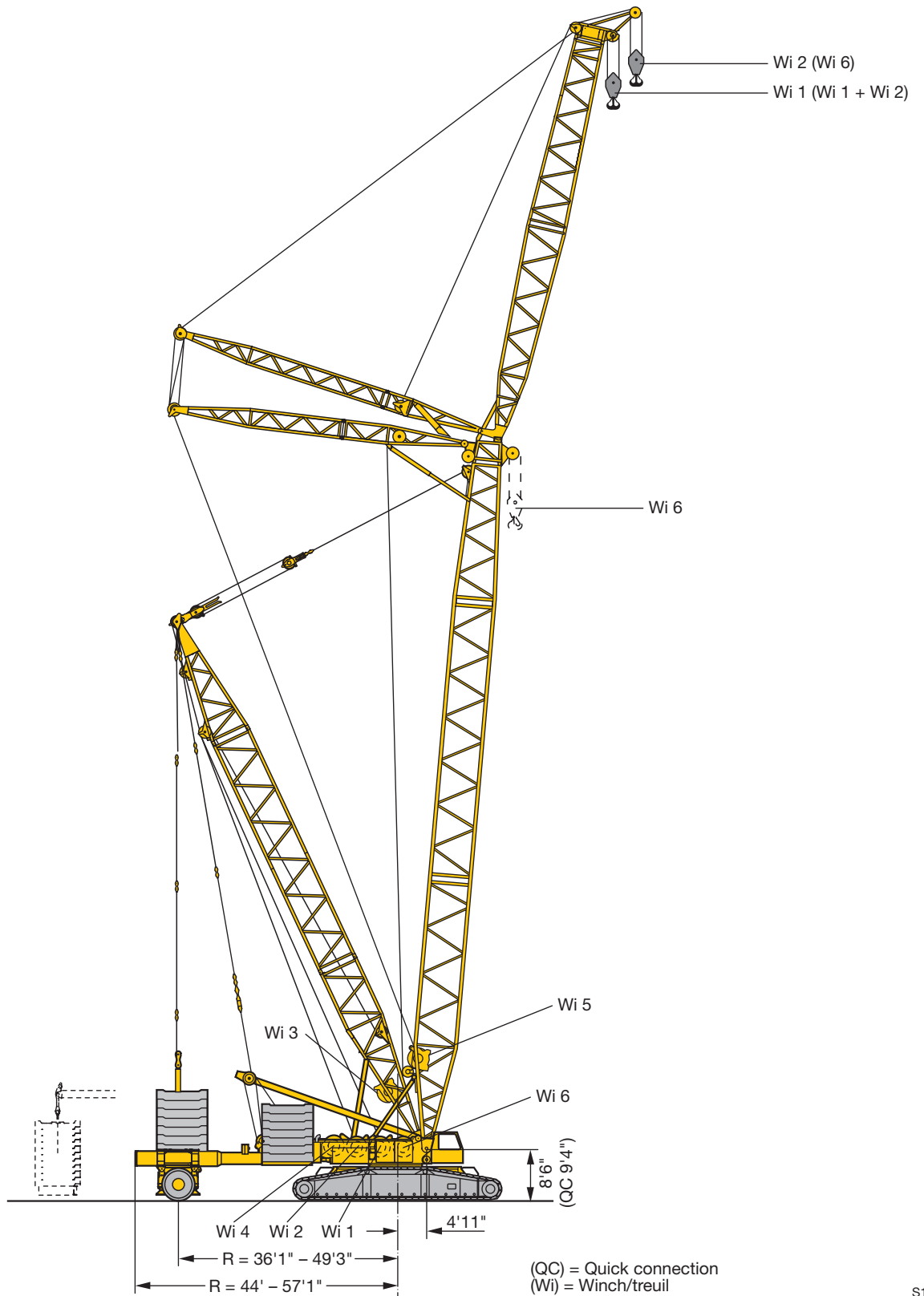

S1529

Working speeds Vitesses



	Driving force with one drive per crawler carrier Puissance propulsive avec un entraînement par porteur-chenille	471870 lbs
	Total driving force with two drives per crawler carrier Puissance propulsive totale avec deux entraînements par porteur-chenille	769545 lbs
	Total weight with main boom S 69 ft, 297700 lbs counterweight, 94800 lbs central ballast and 176 kips hook block Poids total avec flèche principale S 69 ft, contrepoids de 297700 lbs, lest central de 94800 lbs et moufle de 176 kips	661500 lbs
	Ground pressure at 661500 lbs total weight and 3'3" track pads Pression moyenne au sol à de poids total et pains de chenille de 661500 lbs 3'3"	19.6 lbs/inch ²
		0 – 1.1



Drive Mécanismes	Mode Mode	Speeds Vitesses ft/min	Max. single line pull Effort au brin maxi. lbs	Rope diameter Diamètre du câble "	Rope length Longueur du câble ft
	Hoist gear Mécanisme de levage	0 – 440	27560	1"	2789
	Hoist gear Mécanisme de levage	0 – 440	27560	1"	2789
	Derricking main boom/ D-operation Relevage mât principale/ en version D	0 – 476	28660	1"	3051
	Derrick main boom Relevage mât principale	2 x 0 – 230	2 x 27560	1"	1903
	Derricking luffing fly jib Relevage volée variable	0 – 440	27560	1"	2461
	Hoist gear/Whipline Mécanisme de levage/ Poulie brin simple	0 – 440	27560	1"	1640
	0 – 87°	approx. 4 min. for boom length 161 ft env. 4 min. pour longueur de flèche de 161 ft			
		0 – 1,2 rpm			

Hooks blocks and hooks Organes de préhension



Load (kips) Forces de levage (kips)	No. of sheaves Poulies	No. of lines Brins	Weight lbs Poids lbs	Dimension A (ft) Dimension A (ft)
880 (440)	2 x 9 (1 x 9)	2 x 19 (1 x 19)	17600 (11880)	17'5"
550 (275)	2 x 5 (1 x 5)	2 x 11 (1 x 11)	13200 (8360)	15'1"
352	7	15	7700	14'9"
176	3	7	5720	13'9"
79	1	3	3300	13'1"
26,4	-	1	1320	10'6"

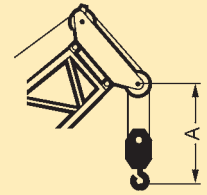

Reeving chart Tableau de mouflage

No. of lines Brins	1	2	3	4	5	6	7	8	9	10	11	12	13	14	15	16	17	18	19
Max. capacity Capacité maxi. kips	26.4	52.9	79.4	105.8	130	156.5	180.7	205	227	249.1	273.3	293.2	315.2	335.1	357.1	377	394.6	415.5	438.7
26.4																			
79																			
176																			
275																			
352																			
440																			

No. of lines Brins	2 x 4	2 x 5	2 x 6	2 x 7	2 x 8	2 x 9	2 x 10	2 x 11	2 x 12	2 x 13	2 x 14	2 x 15	2 x 16	2 x 17	2 x 18	2 x 19
Max. capacity Capacité maxi. kips	211.6	262.3	313	361.5	410	456.3	500.4	551.1	588.6	632.7	672.4	714.2	754	793.6	833.3	881.8
550/275																
880/440																

Transportation plan Plan de transport

Superstructure with winch IV incl. rope and Quick Connection
Partie tournante avec treuil IV incl. câble et dispositif de liaison

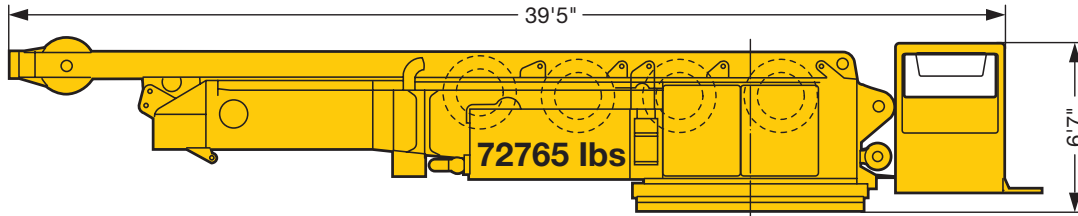

Superstructure with winch IV incl. rope and center section without Quick Connection
Partie tournante avec treuil IV incl. câble et partie centrale sans dispositif de liaison

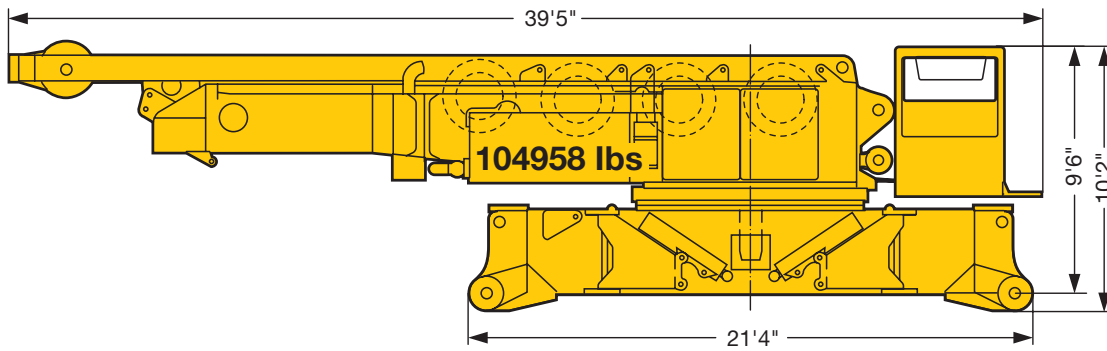

Crawler center section with Quick Connection
Partie centrale avec dispositif de liaison

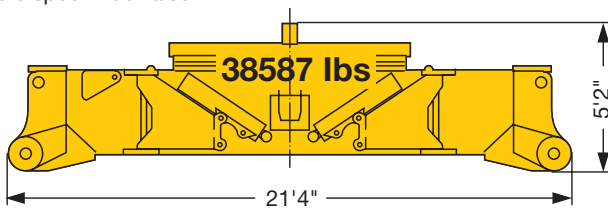

Winch 1/2 incl. rops
Treuil 1/2 incl. câble

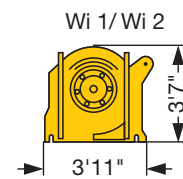

Crawler
Chenille

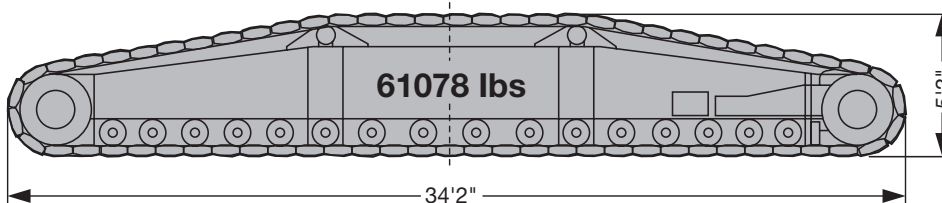

Wi = winch/treuil

S1530

Transportation plan Plan de transport

Counterweight versions
Variantes de contrepoids

CWT at superstructure
Contrepoids tourelle

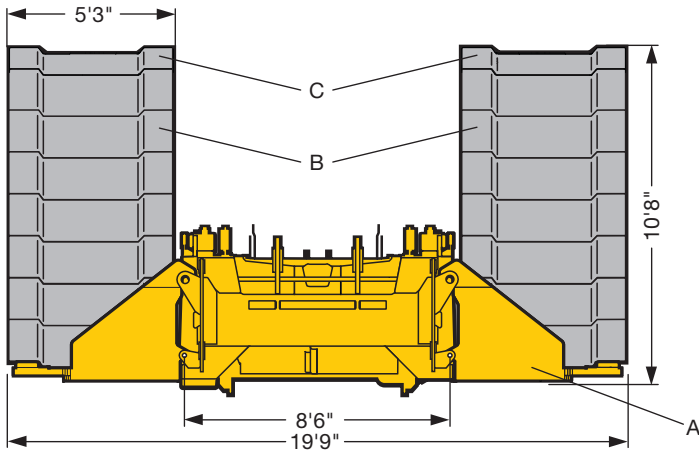

Central CWT
Lest central

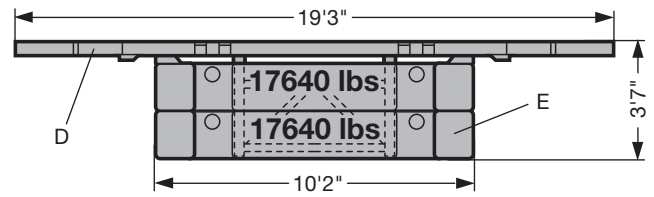

Part A

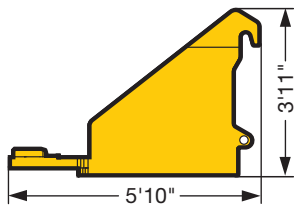

Part B

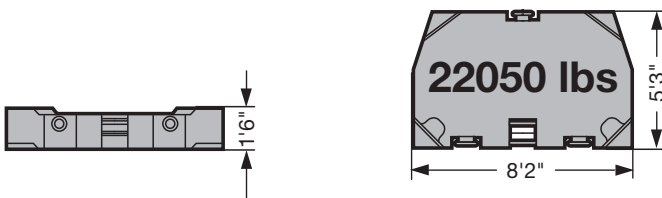

Part C

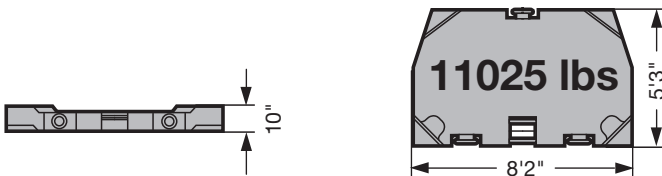

Part D

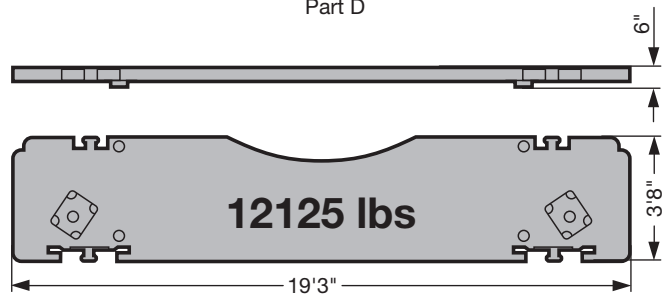

Part E

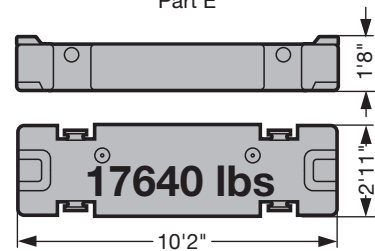

	Part A à 5500 lbs	Part B à 22050 lbs	Part C à 11025 lbs
297650 lbs	2 x	12 x	2 x
341750 lbs	2 x	14 x	2 x

	Part D à 12125 lbs	Part E à 17640 lbs
24250 lbs	2 x	0 x
94810 lbs	2 x	4 x

US2258

Transportation plan Plan de transport

Boom intermediate sections Éléments de flèches intermédiaires	B x H	Base length Longueur de base	Transport length Longueur de transport	Weight lbs* Poids lbs*
LA 2620.10	9'2" x 7'10"	23'	24'3"	6400
		45'11"	47'3"	11900
LA 2620.8	9'2" x 7'10"	45'11"	47'3"	9700
NA 2115.10	7'7" x 5'11"	23'	24'3"	3300
		45'11"	47'3"	6200
NI 1812.10	6'7" x 4'11"	23'	24'3"	3000
		45'11"	47'3"	5500
D 2115.20	8'2" x 6'3"	23'	24'3"	5950
S 2620.20	9'2" x 7'10"	23'	24'3"	8160
		45'11"	47'3"	15200
W 2116.20	7'10" x 6'3"	23'	24'3"	3750
		45'11"	47'3"	6600

* Weights incl. guy rods and bolts / Poids avec barres de haubanage et boulons

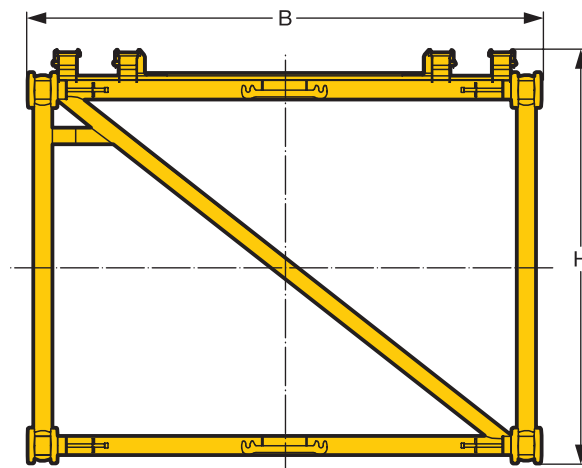

Boom/jib combinations Configurations de flèche

Light weight design
Conception légère

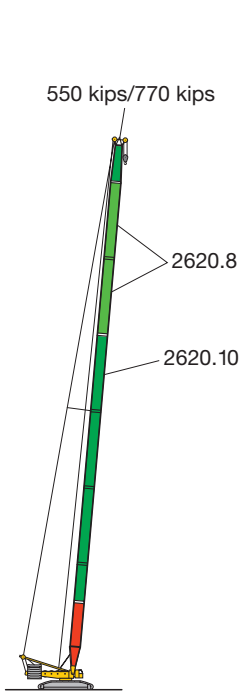

L
69 ft – 322 ft

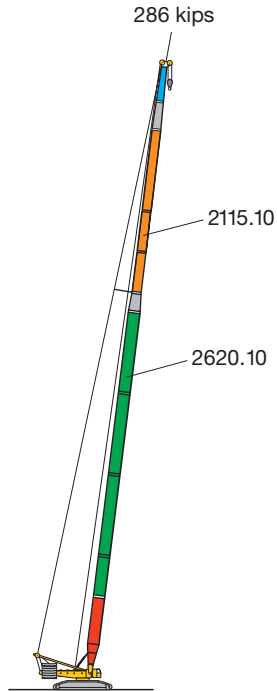

LL
LL 161 ft – 344 ft

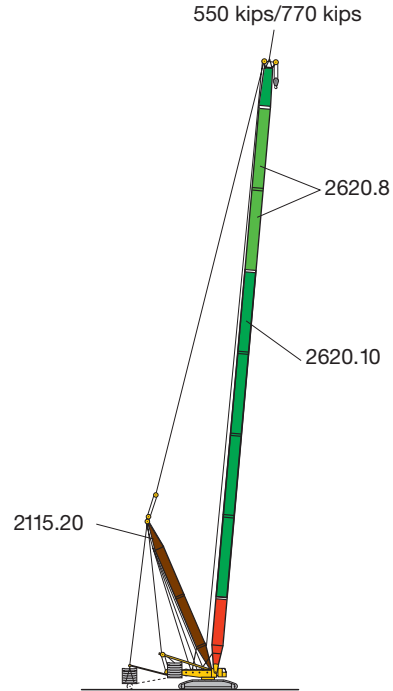

LD, LDB/BW
L 92 ft – 344 ft
D 69 ft – 92 ft

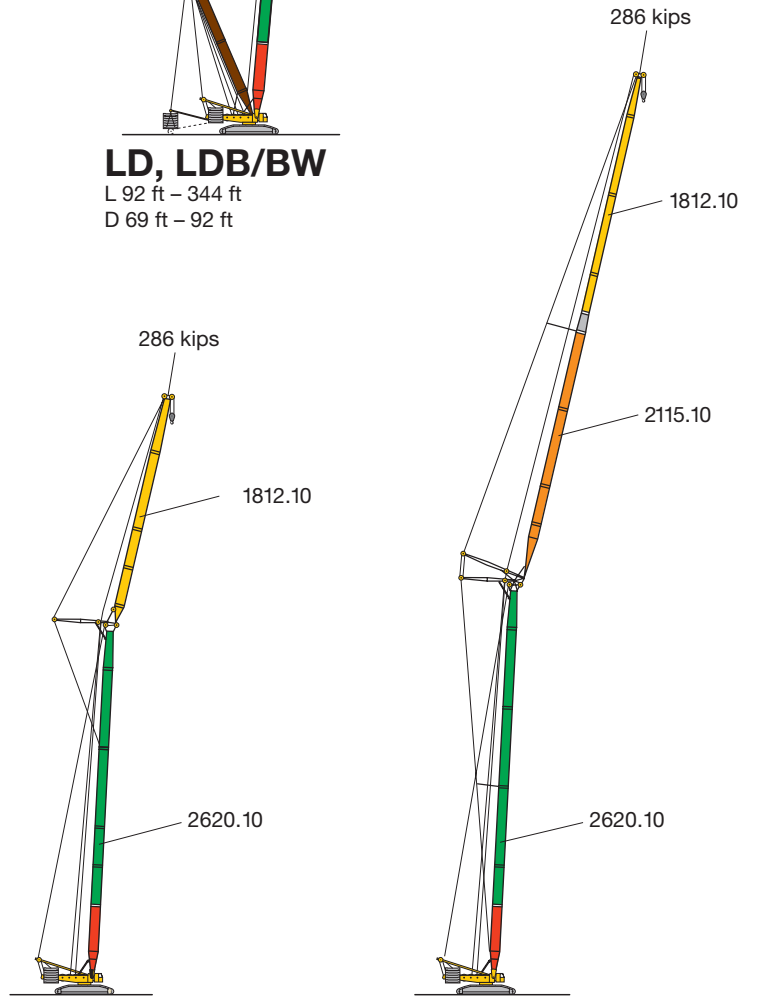

LF
L 115 ft – 230 ft
F 34 ft – 126 ft

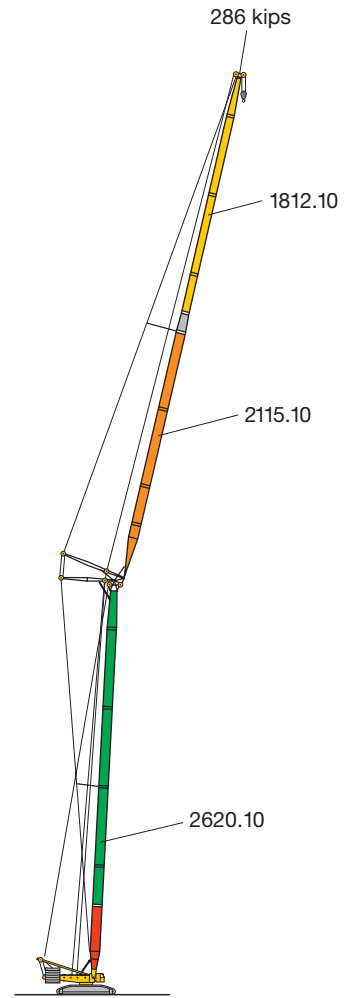

LN
L 69 ft – 230 ft
N 69 ft – 299 ft

- L** Main boom
Flèche principale
- LL** Main boom, light
Flèche principale, légère
- N** Luffing jib, light
Fléchette, légère
- F** Lattice fly jib
Fléchette treillis fixe
- D** Derrick
Flèche derrick
- B** Suspended ballast
Lest suspendu
- BW** Ballast trailer
Porteur de lest

S1532

Boom/jib combinations Configurations de flèche

Heavy weight design
Conception lourde

- S** Main boom, heavy
Flèche principale, lourde
- L** Main boom, light
Flèche principale, légère
- N** Luffing jib, light
Fléchette, légère
- w/W** Luffing jib, heavy
Fléchette, lourde
- D** Derrick
Flèche derrick
- B** Suspended ballast
Lest suspendu
- BW** Ballast trailer
Porteur de lest

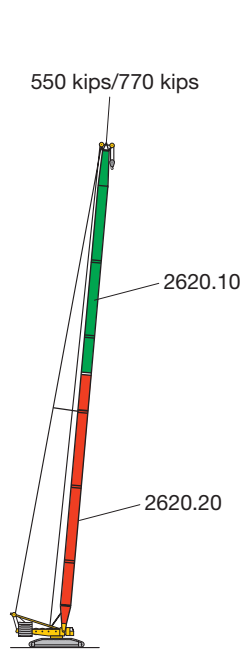

SL
SL 69 ft – 299 ft

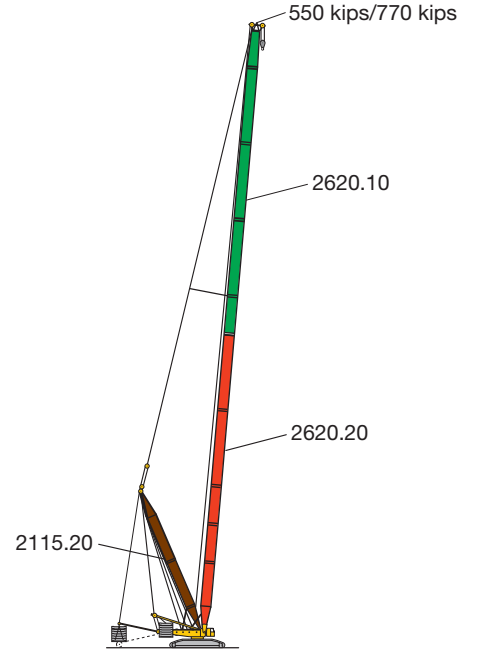

SLD/SLDB/BW
SL 92 ft – 367 ft
D 69 ft – 92 ft

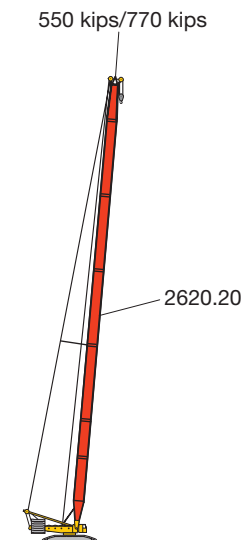

S
S 69 ft – 276 ft

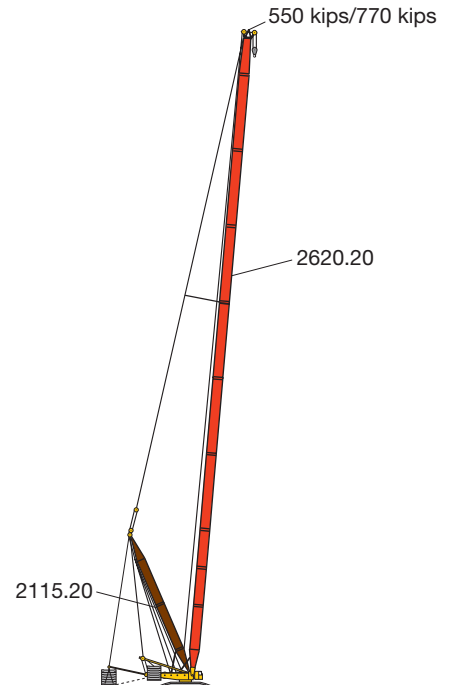

SD/SDB/BW
S 92 ft – 390 ft
D 69 ft – 92 ft

Boom/jib combinations Configurations de flèche

Heavy weight design
Conception lourde

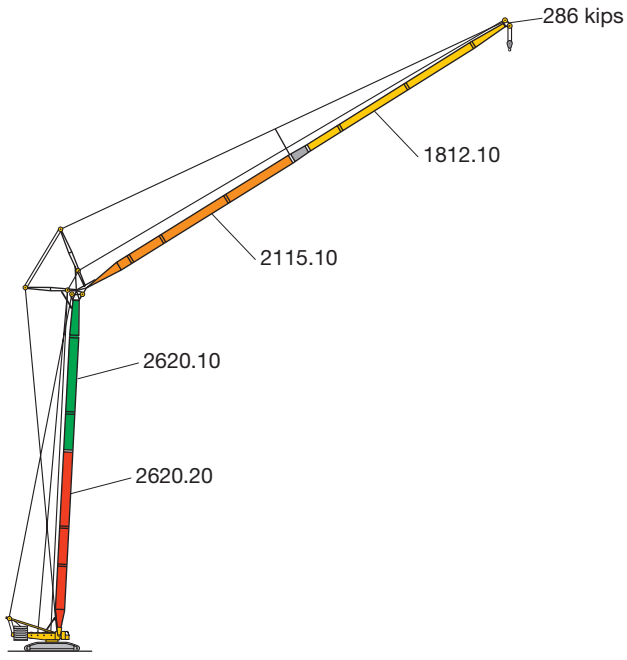

SLN
SL 69 ft – 207 ft
N 69 ft – 299 ft

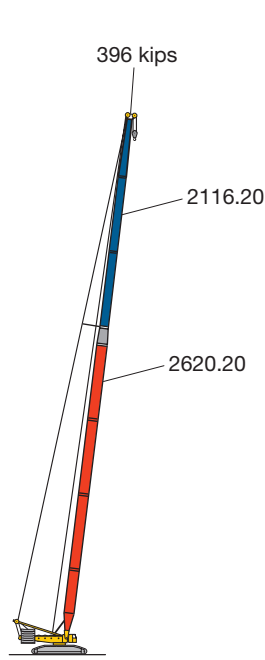

Sw
Sw 92 ft – 322 ft

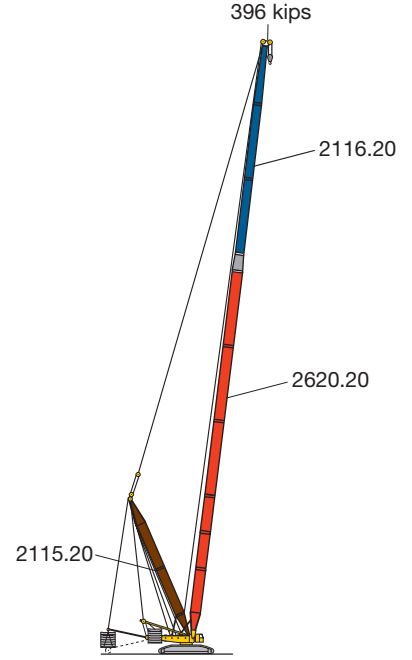

SwD/SwDB/BW
Sw 115 ft – 367 ft
D 69 ft – 92 ft

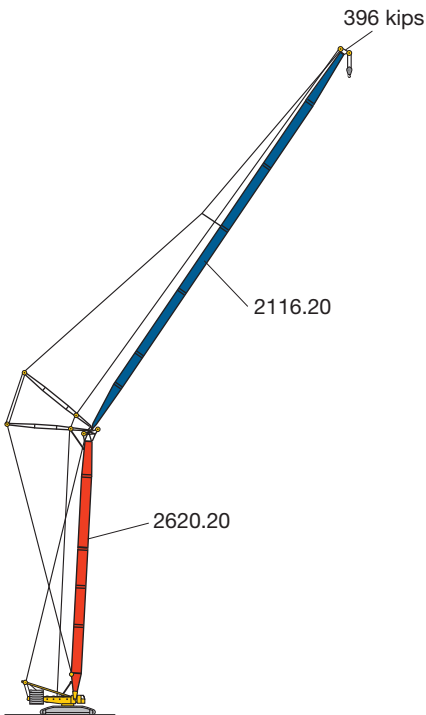

SW
S 92 ft – 161 ft
W 92 ft – 276 ft

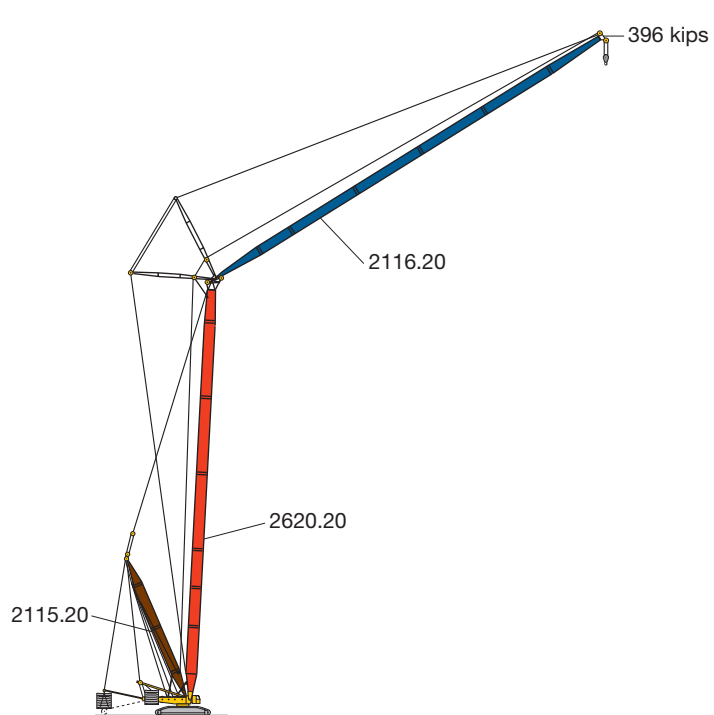

SDWB/BW
S 115 ft – 276 ft
W 92 ft – 299 ft
D 69 ft – 92 ft

S1533

Lifting capacities on L boom

Forces de levage à la flèche principale L

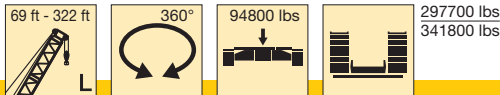

ft	69 ft	92 ft	115 ft	138 ft	161 ft	184 ft	207 ft	230 ft	253 ft	276 ft	299 ft	322 ft	ft
15	864												15
16	790												16
17	749												17
18	728												18
19	706												19
20	681	655											20
21	651	635											21
22	623	611											22
23	597	586	574	562									23
24	576	565	553	548									24
26	533	523	512	522									26
28	497	488	500	489	469								28
30	463	456	467	457	449	395							30
32	431	428	439	430	421	389							32
34	401	410	413	405	396	373	317	273					34
36	373	381	387	383	372	352	312	268					36
38	350	357	363	359	352	334	307	263	223				38
40	329	335	341	337	332	316	299	258	219	182			40
45	285	291	295	291	288	280	267	245	209	172			45
50	252	257	260	256	254	250	239	226	199	163	150	128	50
55	225	229	231	227	225	225	216	207	189	155	144	124	55
60	202	205	207	204	201	204	196	188	178	146	138	119	60
65	183	186	188	184	181	187	179	172	166	139	133	114	65
70		171	172	168	165	170	165	158	153	131	127	110	70
75		157	158	154	151	155	152	146	141	124	121	105	75
80		145	145	142	139	141	140	135	131	118	116	100	80
85		134	134	131	128	129	128	126	122	112	111	95	85
90			124	122	119	119	118	117	113	106	104	91	90
95			115	113	111	111	109	108	106	100	98	86.5	95
100			108	105	103	103	101	100	99	95	91.5	82.5	100
105				98	96.5	95.5	94.5	93	92.5	89	85.5	78.5	105
110				92	90.5	89.5	88	86.5	86	83.5	80.5	74	110
115				87	85	84	82.5	81	80.5	78.5	75.5	70.5	115
120				82	80	78.5	77.5	75.5	75	73.5	71	67	120
125					75.5	74	72.5	71	70.5	69	67	63	125
130					71.5	69.5	68.5	66.5	66	64.5	63	59.2	130
135					67.5	66	64.5	63	62	60.5	59.3	55.6	135
140					64	62.5	61	59.3	58.6	57	55.8	52.1	140
150						56.2	54.6	52.9	52.1	50.5	49.4	45.7	150
160							49.1	47.2	46.4	44.7	43.5	39.9	160
170							44.3	42.4	41.5	39.5	38.4	34.8	170
180							40.3	38.1	37	35	33.9	30.3	180
190								34.2	33	30.9	29.8	26.3	190
200									29.4	27.3	26.1	22.5	200
210										26.2	24	22.7	210
220										23.4	21.1	19.9	220
230											18.3	16.8	230
240											15.3	13.4	240
250												10	250
260												7.5	260

TAB 124088 / 124089

Lifting heights on L boom Hauteur de levage à la flèche principale L

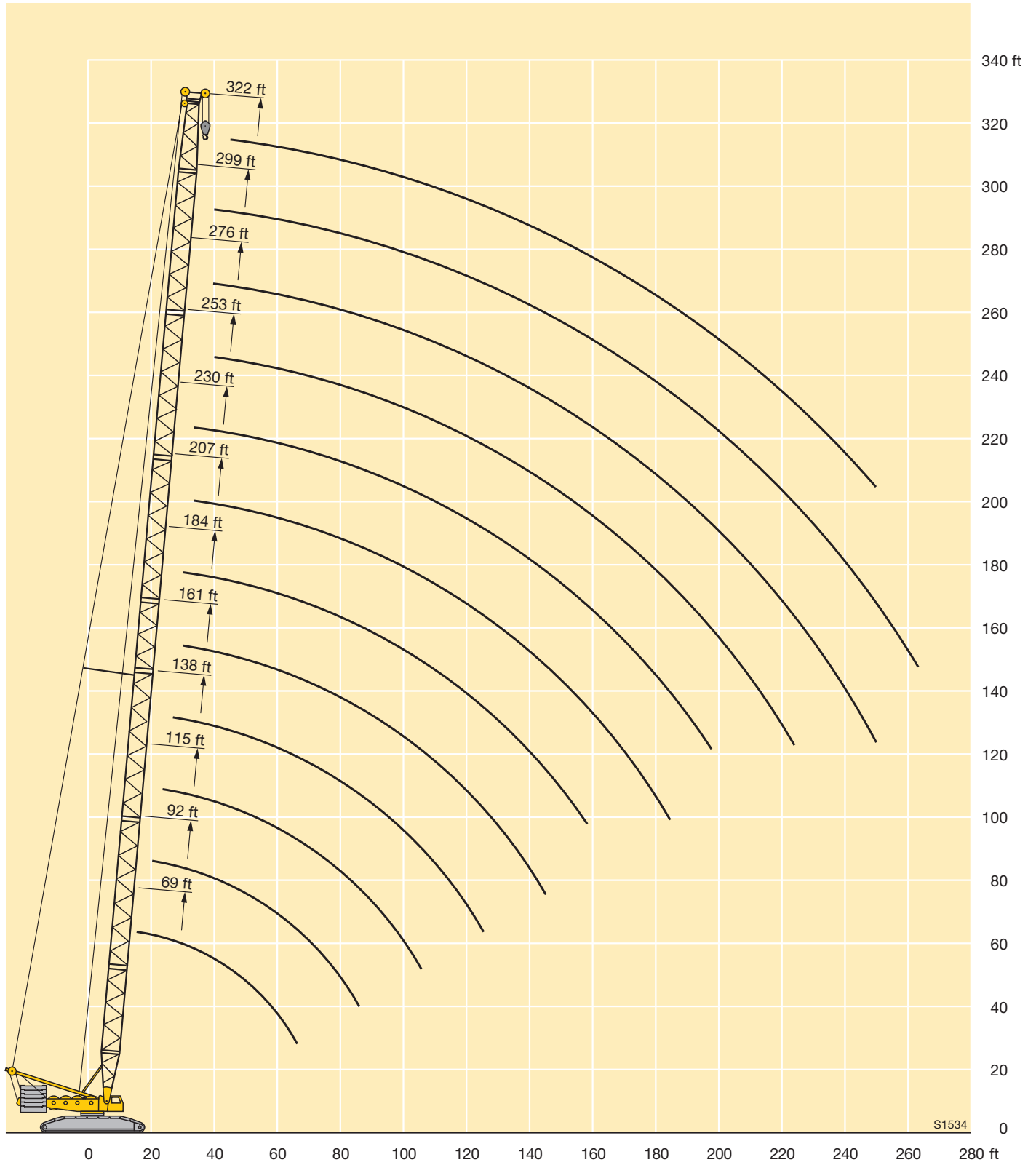

Lifting capacities on LL boom

Forces de levage à la flèche principale LL

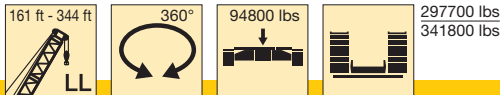

ft	161 ft	184 ft	207 ft	230 ft	253 ft	276 ft	299 ft	322 ft	344 ft	ft
30	287	268								30
32	287	253								32
34	287	241	198							34
36	287	230	196							36
38	272	220	192	186						38
40	259	211	188	182	178					40
45	236	189	178	174	169					45
50	213	172	170	165	159	133				50
55	194	156	161	157	150	127	118	93		55
60	179	144	153	148	142	120	112	89.5	76.5	60
65	167	134	144	140	133	114	107	85.5	72	65
70	157	125	137	132	124	108	101	82	68.5	70
75	149	117	130	124	116	103	95	78	65.5	75
80	140	111	122	115	109	97	89	74	62.5	80
85	131	106	117	108	102	91.5	84	71	59.7	85
90	124	101	111	102	95	86.5	80	68	57.2	90
95	118	96	106	95	89.5	82	75.5	65.5	55.2	95
100	112	91.5	101	89	84.5	77.5	71.5	63	53.2	100
105	105	87	96	84	79.5	73.5	67	60.5	50.7	105
110	99	83	91.5	80.5	76	69.5	64	58.1	49	110
115	93.5	78.5	87	76.5	72.5	66	60.5	55.6	47.3	115
120	88	74.5	82.5	72.5	69.5	62.5	57.2	53.1	45.7	120
125	83.5	70.5	79	69.5	66	59.4	53.9	50.6	44	125
130	79.5	67	76	67	63.5	56.8	51.3	48.9	42.3	130
135	75	64	72.5	64	60.5	54.3	49.1	46.9	40.6	135
140	70	61	69	61.5	57.7	51.8	47	44.8	38.9	140
150		55.1	63	56.7	52.3	47.2	43.3	41.1	36.1	150
160			57.9	51.6	47.7	43.3	39.9	37.7	33.3	160
170			53	46.6	44.3	39.9	36.6	34.4	30	170
180			48.1	42.4	40.9	36.5	33.2	31	27.4	180
190				38.2	37.6	33.2	30.4	28.2	24.9	190
200					34.2	29.8	27.6	25.4	22.4	200
210					30.9	26.5	24.2	22	19.8	210
220					27.5	23.9	21.7	20	17.3	220
230						21.4	19.2	17.7	14.8	230
240							16.7	15.1	12.3	240
250							14.2	12.4	9.8	250
260							12.5	10.4	8.1	260
270								8	5.8	270

TAB 124095 / 124096

Remarks referring to load charts

- When calculating crane stresses and loads, German Industrial Standards (DIN) are applicable, in conformance with new German legislation (published 2/85). The lifting capacities (stability margin) DIN/ISO correspond to DIN 15019, part 2, and ISO 4305 (Tested load = 1.25 x lifting capacity + 0.1 x boom dead weight, reduced to the boom point). The crane's structural steel work is in accordance with DIN 15018, part 3. Design and construction of the crane comply with DIN 15018, part 2 and with F.E.M. regulations.
- Lifting capacities are given in kips.
- The weight of the load hook and hook blocks as well as of the lifting tackle must be deducted from the lifting capacities.
- The working radii are measured from the slewing centreline.
- The subsoil must be even and of good bearing capacity.
- Subject to modification of lifting capacities.
- Loads above 771750 lbs, only with 972405 lbs head section.
- The crane can be displaced with suspended loads as stated in the load charts. Operating conditions must conform to the rules in the operating instructions.

Lifting heights on LL boom Hauteur de levage à la flèche principale LL

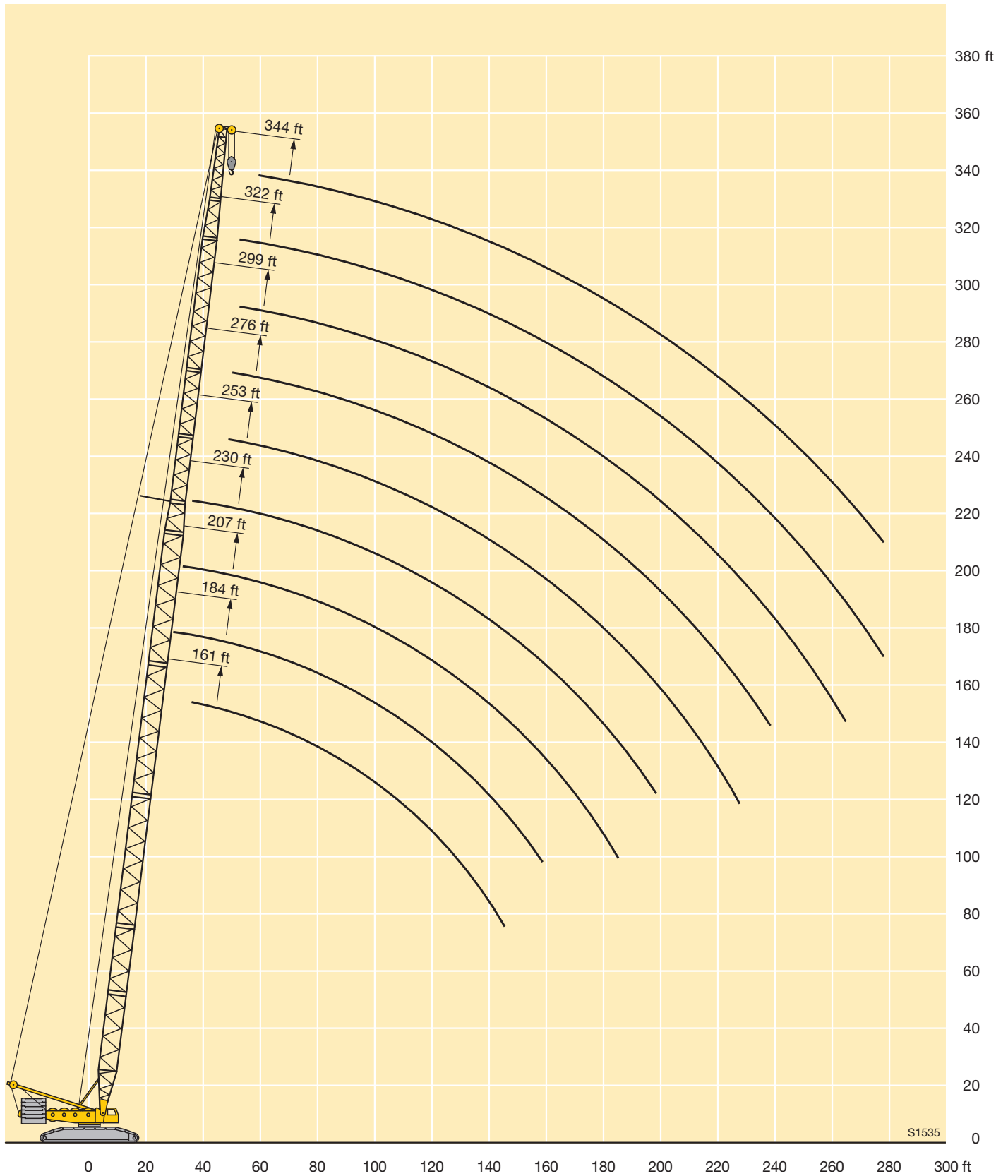

Lifting capacities on LD boom/derrick combination

Forces de levage en configuration LD

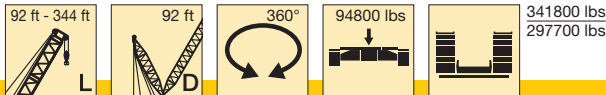

ft	92 ft	115 ft	138 ft	161 ft	184 ft	207 ft	230 ft	253 ft	276 ft	299 ft	322 ft	344 ft	ft
20	675												20
21	648												21
22	622												22
23	597	587	576										23
24	575	566	556										24
26	532	524	515										26
28	497	490	481	467									28
30	464	457	449	433	407								30
32	436	430	422	405	381								32
34	409	405	398	380	358	367	320						34
36	383	382	376	356	337	354	320						36
38	359	359	355	337	319	336	313	276					38
40	337	338	335	319	302	319	304	274	227				40
45	292	292	291	280	267	283	270	257	223				45
50	256	256	255	250	238	252	243	234	217	182	155		50
55	228	227	226	223	214	224	219	212	204	180	154	132	55
60	204	203	202	201	194	199	198	193	185	176	154	132	60
65	185	184	182	181	177	179	177	177	170	164	154	132	65
70	169	167	166	164	162	162	161	160	157	152	145	132	70
75	155	153	151	150	148	148	146	145	143	140	135	128	75
80	143	141	139	137	135	135	133	133	131	130	125	120	80
85	133	130	128	126	124	124	122	121	119	119	116	111	85
90		121	119	117	115	114	112	112	110	109	106	104	90
95		113	111	109	106	106	104	103	101	101	97.5	96	95
100		106	103	101	98.5	98	96	95	93	92.5	89.5	88.5	100
105			96.5	94	91.5	91	89	88	86	85.5	82.5	81.5	105
110			90.5	88.5	85.5	85	82.5	82	80	79.5	76	75	110
115			85.5	83	80	79.5	77	76	74	73.5	70.5	69	115
120			80.5	78	75	74	72	71	68.5	68	65	63.5	120
125				73	70.5	69.5	67	66	64	63	60	58.8	125
130				69	66	65	62.5	61.5	59.4	58.8	55.8	54.4	130
135				65.5	62.5	61	58.9	57.8	55.5	54.8	51.8	50.4	135
140				62	58.8	57.6	55.2	54.1	51.7	51	48	46.5	140
150					52.5	51	48.5	47.4	45	44.1	41.1	39.6	150
160						45.3	42.7	41.5	39	38.1	35.1	33.5	160
170						40.4	37.7	36.4	33.8	32.9	29.8	28.1	170
180						36.2	33.4	32	29.3	28.3	25.2	23.5	180
190							29.5	28	25.3	24.2	21.1	19.4	190
200								24.5	21.7	20.6	17.4	15.5	200
210								21.3	18.4	17.2	14.1	11.7	210
220								18.6	15.6	14.3	11.2	8.9	220
230									13	11.6			230
240									10.8				240

TAB 124102 / 124103

Remarques relatives aux tableaux des charges

1. La grue est calculée selon normes DIN conformément au décret fédéral 2/85. Les charges DIN/ISO respectent les sécurités au basculement requises par les normes DIN 15019, partie 2 et ISO 4305. La structure de la grue est conçue selon la norme DIN 15018, partie 3. La conception générale est réalisée selon la norme DIN 15018, partie 2, ainsi que selon les recommandations de la F.E.M.
2. Les charges sont indiquées en kips.
3. Les poids du crochet ou du moufle ainsi que des élingues sont à déduire des charges indiquées.
4. Les portées sont prises à partir de l'axe de rotation de la partie tournante.
5. Le sol doit être plat et résistant.
6. Charges données sous réserve de modification.
7. Charges dépassant 771750 lbs seulement avec élément de tête de 972405 lbs.
8. La grue peut être déplacée avec les charges indiquées dans les tableaux des charges. Les conditions de service sont stipulées dans les instructions de service.

Lifting capacities on LDB/LDBW boom/derrick combination

Forces de levage en configuration LDB/LDBW

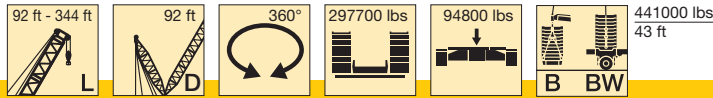

ft	92 ft	115 ft	138 ft	161 ft	184 ft	207 ft	230 ft	253 ft	276 ft	299 ft	322 ft	344 ft	ft
20	772												20
21	772												21
22	772												22
23	771	661	595										23
24	751	661	595										24
26	710	661	595										26
28	682	647	595	529									28
30	657	632	593	529	474								30
32	640	622	585	529	474								32
34	625	612	579	528	474	375	320						34
36	611	604	573	525	473	375	320						36
38	602	596	566	522	472	375	320	276					38
40	592	588	556	517	472	375	319	276	227				40
45	566	565	522	491	470	373	317	276	223				45
50	540	535	492	464	455	372	314	273	220	182	155		50
55	508	506	465	438	435	370	311	269	217	180	154	132	55
60	467	479	441	415	412	366	308	266	215	178	154	132	60
65	418	455	419	394	391	351	305	262	212	175	154	132	65
70	375	421	399	376	372	335	303	258	209	173	153	132	70
75	336	389	379	358	355	320	297	255	205	170	152	132	75
80	300	360	359	342	339	305	288	251	202	167	152	132	80
85	269	332	334	327	324	291	274	248	199	165	152	132	85
90		305	313	310	310	280	262	244	197	162	151	132	90
95		279	294	293	293	268	252	236	194	157	150	131	95
100		256	276	275	275	257	241	225	191	151	149	130	100
105			261	259	260	247	232	217	187	145	148	128	105
110			247	245	245	238	223	209	180	140	144	126	110
115			232	231	231	227	215	201	174	134	141	123	115
120			217	219	219	217	207	193	167	129	138	120	120
125				210	210	209	200	186	161	125	134	117	125
130				200	201	199	193	180	155	120	131	113	130
135				191	192	191	187	174	150	117	128	111	135
140				182	183	183	181	168	145	113	124	108	140
150					168	169	168	158	135	107	117	103	150
160						156	156	148	127	102	109	98	160
170						146	146	139	119	95	104	93	170
180						136	136	131	112	90	99	88	180
190							127	124	104	85.5	94	84	190
200								117	96.5	81.5	88.5	80.5	200
210								111	88	77	82.5	76	210
220								103	83	74	78.5	72	220
230									78	70.5	73.5	69	230
240									73	67.5	69.5	66	240
250										65	66	62.5	250
260										60.5	62.5	59.3	260
270											59.2	55.9	270
280												52.5	280
290												49.3	290
300												46.8	300

TAB 124106 / 124108

Lifting heights on LDB/LDBW boom/derrick combination
Hauteur de levage en configuration LDB/LDBW

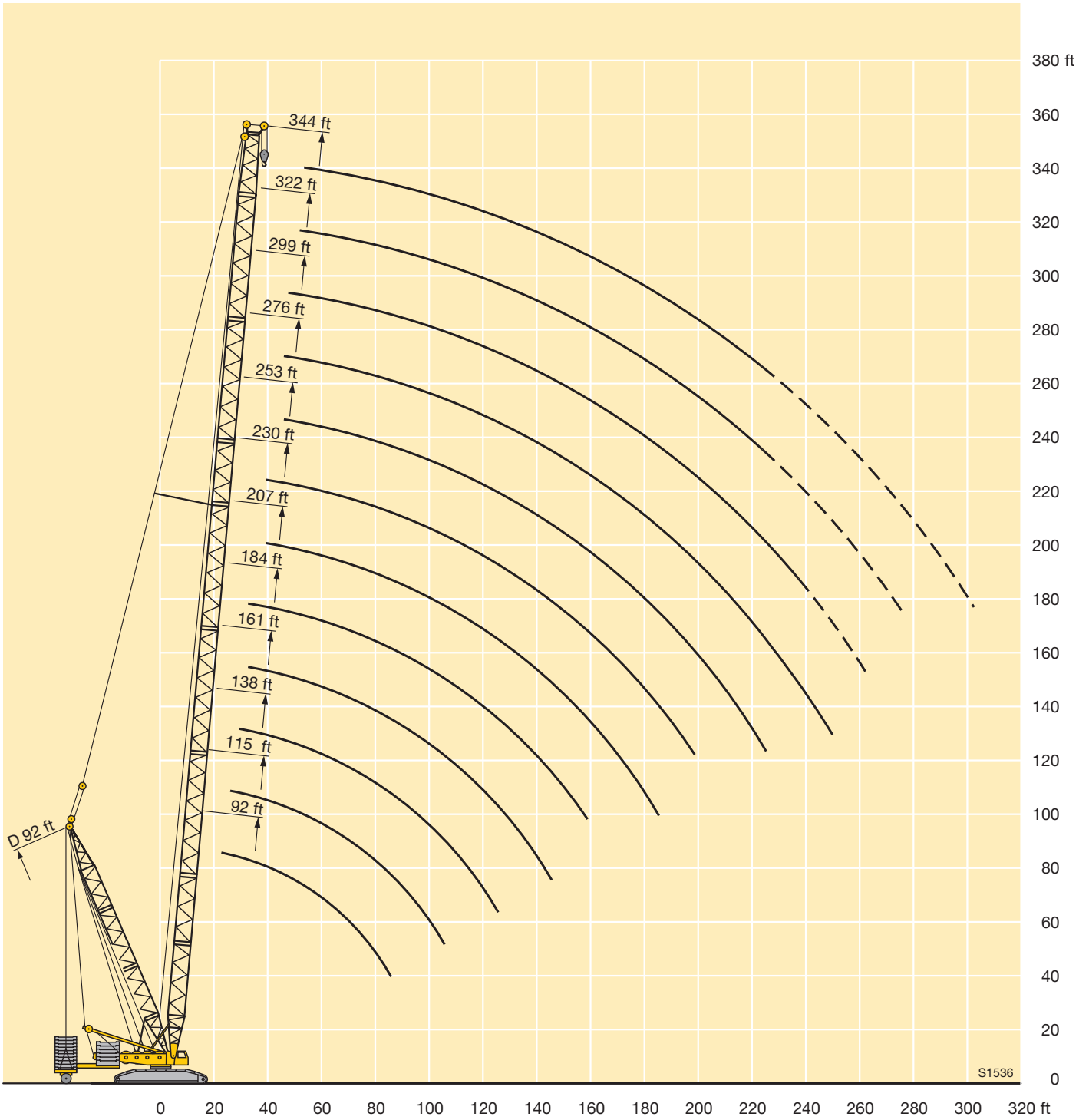

Lifting capacities on LF boom/jib combination

Forces de levage en configuration LF

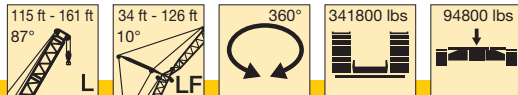

ft	115 ft					138 ft					161 ft					ft
	34 ft	57 ft	80 ft	103 ft	126 ft	34 ft	57 ft	80 ft	103 ft	126 ft	34 ft	57 ft	80 ft	103 ft	126 ft	
34	287					287					278					34
36	287					287					273					36
38	287	273				287					272					38
40	287	269				286	237				270	215				40
45	287	256				280	226				259	206				45
50	266	244	208			255	216	183			240	198	166			50
55	242	230	199	169		230	207	175	152		219	190	159			55
60	218	213	190	166	127	208	198	168	145	119	199	183	153	132	114	60
65	195	195	182	160	128	190	186	161	140	119	181	176	148	127	111	65
70	176	177	174	153	128	173	172	155	135	118	167	164	142	122	107	70
75	160	162	162	148	128	158	158	149	130	114	154	152	137	118	103	75
80	146	148	149	142	126	144	146	143	125	110	142	141	133	114	100	80
85	134	136	137	137	122	132	134	135	120	107	130	131	128	110	97	85
90	124	125	127	128	117	122	124	125	116	103	120	122	121	106	93.5	90
95	115	116	118	119	113	113	115	116	112	99.5	111	113	114	103	90.5	95
100	107	108	110	111	109	105	106	108	108	96	103	105	106	99.5	87.5	100
105	99.5	101	102	103	104	97	99	101	102	93	95.5	97.5	99.5	96.5	84.5	105
110	93	94.5	96	97	97.5	91	92.5	94	95.5	90	89	91.5	93	93	82	110
115	87.5	88.5	90	91	91.5	85	87	88.5	89.5	87	83.5	85.5	87	88	79.5	115
120	82	83.5	84.5	85.5	86.5	80	81.5	83	84	84	78	80	81.5	82.5	77	120
125	77.5	78.5	80	80.5	81.5	75	76.5	78	79	80	73.5	75	76.5	77.5	75	125
130	73	74	75.5	76.5	77	71	72	73.5	74.5	75.5	69	71	72	73	72.5	130
135		70.5	71.5	72.5	73	67	68.5	70	71	71.5	65	67	68	69	69.5	135
140		66.5	68	68.5	69	63.5	64.5	66	67	67.5	61.5	63	64.5	65	66	140
150		60	61	62	62.5	56.7	58	59.3	60	61	54.8	56.5	57.7	58.4	59.2	150
160			55.4	56	56.5		52.2	53.4	54.3	54.9	49.1	50.6	51.8	52.4	53.2	160
170			50.3	50.9	51.4		47.2	48.4	49.1	49.8	44.1	45.6	46.6	47.3	48	170
180				46.6	47		44	44.7	45.3			41.2	42.3	42.8	43.5	180
190				42.6	43			40.1	40.8	41.3		37.2	38.3	38.8	39.5	190
200					39.5				37.2	37.7			34.7	35.2	35.8	200
210					36.3				34	34.5				31.7	32.4	210
220					33.5				30.9	31.5				28.7	29.3	220
230										28.7				25.9	26.5	230
240															23.9	240
250															21.5	250
260															19.3	260

TAB 124241

Lifting capacities on LF boom/jib combination

Forces de levage en configuration LF

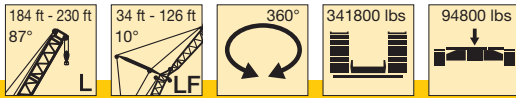

ft	184 ft					207 ft					230 ft			ft
	34 ft	57 ft	80 ft	103 ft	126 ft	34 ft	57 ft	80 ft	103 ft	126 ft	34 ft	57 ft	80 ft	
38	247													38
40	244					223								40
45	239					216								45
50	226	183				211	169					192		50
55	209	177	147			200	164	136				186	151	55
60	190	171	142	121		181	159	132	112			173	147	60
65	173	165	137	117		166	154	127	109			159	143	65
70	159	156	133	113	99	152	148	124	105	91.5		146	140	70
75	147	145	128	110	96	140	139	120	102	88.5		134	133	75
80	136	135	124	106	93	130	129	117	99	86		124	124	80
85	126	125	120	103	90	120	120	113	96.5	83.5		115	115	85
90	117	117	115	99.5	87	112	112	110	93.5	81.5		107	107	90
95	109	109	109	96.5	84.5	104	104	104	90.5	79		99.5	100	95
100	101	102	102	93.5	82	97.5	97.5	97.5	88	76.5		93	93	100
105	94	96	96	91	79.5	91	91.5	91	85.5	74.5		86.5	87	105
110	87.5	89.5	90.5	88	77	85.5	86	86	83	72		81	82	110
115	81.5	83.5	85	84.5	74.5	80	80.5	80.5	79.5	70		76	76.5	115
120	76.5	78	80	80	72.5	74.5	76	76	75.5	68.5		71.5	72	120
125	71.5	73	75	75.5	70.5	70	71.5	71.5	71.5	66.5		67	67.5	125
130	67	69	70.5	71.5	68.5	65.5	67	67.5	67.5	64.5		63	64	130
135	63	65	66.5	67.5	66	61.5	63.5	64	64	62.5		59.3	60	135
140	59.5	61	63	63.5	63.5	57.8	59.6	60.5	60.5	59.7		55.8	56.7	140
150	52.9	54.4	56	56.9	57.7	51.2	52.8	54.1	54.2	54.3		49.3	50.4	150
160	47.1	48.5	50.1	50.9	51.8	45.3	46.9	48.2	48.6	48.7		43.3	44.8	160
170	42.1	43.4	44.9	45.7	46.5	40	41.7	43	43.6	43.8		37.9	39.7	170
180	37.5	38.9	40.5	41.2	42	35.4	37	38.3	38.9	39.3		33.2	35	180
190	33.4	34.8	36.3	37	37.9	31.2	32.7	34.1	34.6	35.1		29	30.7	190
200		31	32.5	33.2	34.1	27.5	28.9	30.2	30.8	31.2		25.2	26.8	200
210			29	29.7	30.5		25.5	26.7	27.2	27.7		21.8	23.3	210
220			26	26.6	27.4		22.5	23.6	24.2	24.6		18.9	20.3	220
230			23.1	23.7	24.5		19.7	20.8	21.4	21.7		16.2	17.5	230
240				21.1	21.9			18.3	18.8	19.1			14.9	240
250				18.7	19.4			15.9	16.4	16.7				250
260				16.5	17.2			13.8	14.2	14.5				260
270					15.2				12.2	12.4				270
280										10.4				280
290										8.7				290
300										7.5				300

TAB 124241

Lifting heights on LF boom/jib combination
Hauteur de levage en configuration LF

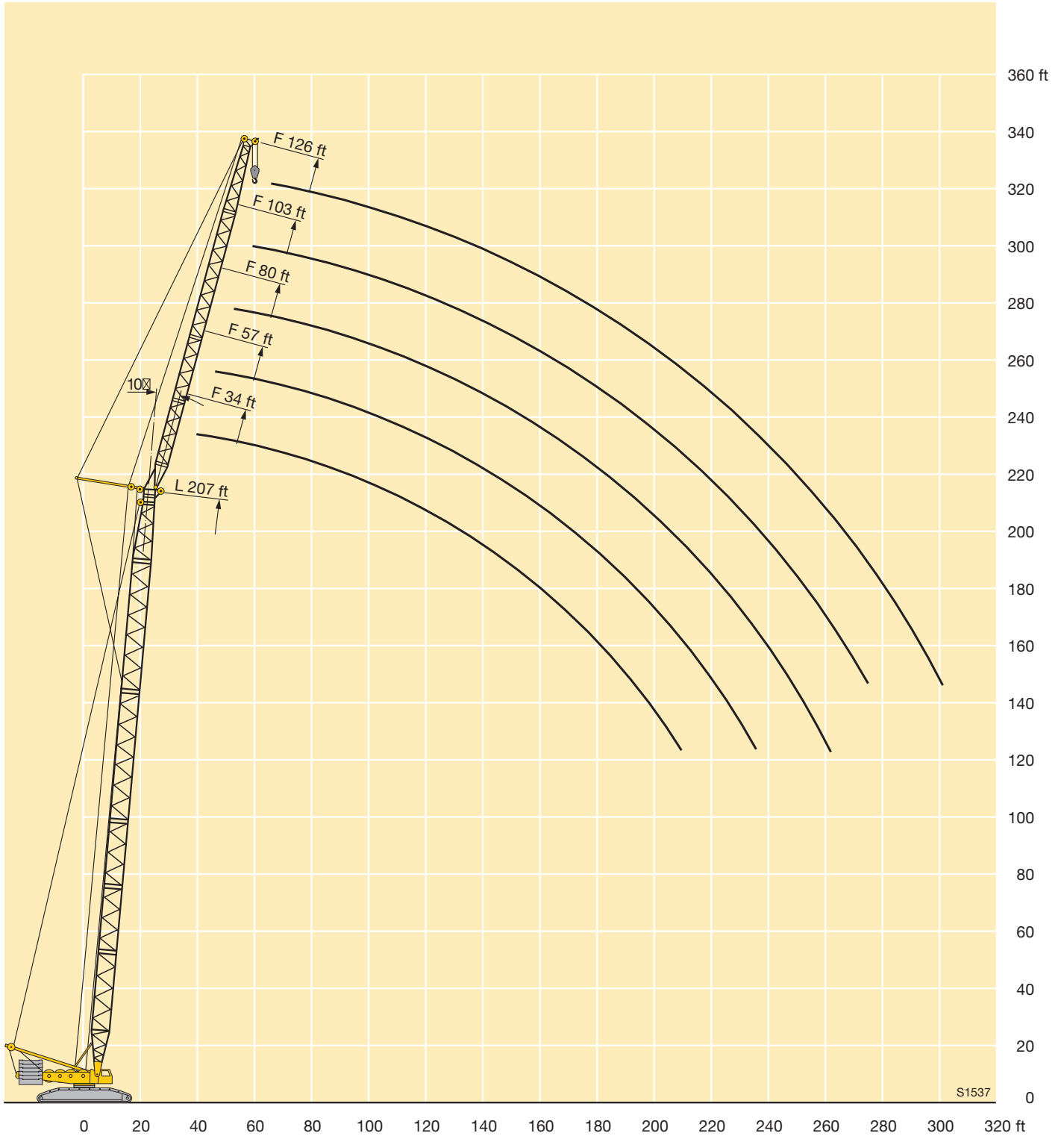

Lifting capacities on LF boom/jib combination

Forces de levage en configuration LF

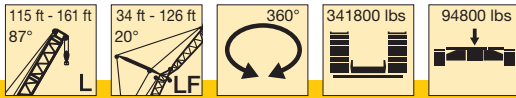

ft	115 ft					138 ft					161 ft					ft
	34 ft	57 ft	80 ft	103 ft	126 ft	34 ft	57 ft	80 ft	103 ft	126 ft	34 ft	57 ft	80 ft	103 ft	126 ft	
38	287															38
40	286					256					232					40
45	279					246					224					45
50	265					238					217					50
55	244	206				226	180				210	163				55
60	220	199	168			211	174	145			202	158	130			60
65	197	192	162			193	168	140			184	153	126			65
70	177	179	156	134		175	163	135			169	149	122			70
75	161	164	150	129		160	157	131	113		156	144	119	102		75
80	147	150	144	124	108	146	149	127	109	96	144	140	115	98.5		80
85	135	138	139	119	105	133	137	123	106	93	132	134	112	95.5		85
90	125	128	129	114	101	123	127	120	103	90.5	122	125	109	93	81	90
95	116	118	121	110	97	114	117	116	99.5	87.5	113	116	106	90.5	78.5	95
100	107	110	112	106	93	106	109	111	97	85	104	107	103	88	76.5	100
105	100	103	105	102	89.5	98.5	101	103	94	82.5	97	100	100	85.5	74.5	105
110	93.5	96	98	98	86	92	95	97	91.5	80.5	90.5	93.5	95	83.5	72.5	110
115	88	90	92	93	83	86	89	91	89	78	84.5	87.5	89.5	81	70.5	115
120	82.5	85	86.5	88	80	81	83.5	85.5	86	76	79	82	84	79	68.5	120
125	77.5	80	81.5	83	77.5	76	78.5	80.5	81.5	74	74.5	77	79	77	66.5	125
130	73.5	75.5	77.5	78.5	75	71.5	74	76	77	72	70	72.5	74.5	75	65	130
135		71.5	73.5	74.5	72.5	67.5	70	72	73	70	66	68.5	70	72	63.5	135
140		67.5	69.5	70.5	70	64	66	68	69	68.5	62	64.5	66.5	68	62	140
150		61	62.5	63.5	64.5	57.2	59.4	61	62	63	55.5	57.7	59.4	61	58.9	150
160			56.6	57.5	58.3		53.4	55.0	56	57.1	49.7	51.7	53.3	54.8	55.5	160
170			51.3	52.2	53		48.2	49.7	50.7	51.7	44.6	46.5	48	49.4	50.2	170
180			46.8	47.6	48.4			45.2	46.1	47.1		42	43.5	44.8	45.6	180
190				43.5	44.3			41.1	42	42.9		37.9	39.4	40.6	41.4	190
200					40.6				38.2	39.2			35.6	36.9	37.6	200
210					37.2				34.9	35.8			32.1	33.4	34.2	210
220					34.2				31.7	32.7			28.9	30.1	30.9	220
230										29.8				27.1	27.9	230
240										27					25.2	240
250															22.6	250
260															20.2	260

TAB 124244

Lifting capacities on LF boom/jib combination

Forces de levage en configuration LF

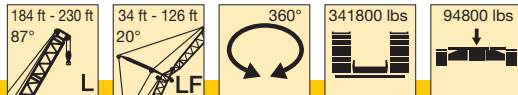

ft	184 ft					207 ft					230 ft				ft
	34 ft	57 ft	80 ft	103 ft	126 ft	34 ft	57 ft	80 ft	103 ft	126 ft	34 ft	57 ft	80 ft	103 ft	
50	200					186					171				50
55	195	151				181	140				167				55
60	188	146				176	136				164	127			60
65	176	142				168	132				160	123			65
70	163	138	113			155	129	105			149	120	98		70
75	150	135	110	93		143	126	102			137	118	95.5		75
80	139	131	107	90.5		132	123	99.5	84		127	115	93.5	78.5	80
85	129	128	104	88		123	120	97	82		118	113	91.5	77	85
90	120	120	101	85.5	74.5	114	114	94.5	80	69	109	109	89.5	75	90
95	111	113	98.5	83.5	72.5	107	108	92.5	78	67	102	104	87.5	73	95
100	103	106	96	81.5	70.5	99.5	101	90	76	65.5	95	96.5	85.5	71.5	100
105	95.5	98.5	94	79	69	93	94.5	88	74	64	89	90.5	83.5	70	105
110	89	92	91.5	77	67	87.5	89	86	72.5	62.5	83.5	85	81.5	68.5	110
115	83.5	86	87.5	75.5	65.5	81.5	83.5	83.5	70.5	61	78	80	79.5	67	115
120	78	80.5	83	73.5	63.5	76	78.5	79.5	69	59.4	73	75	76.5	65.5	120
125	73	75.5	77.5	71.5	62	71	74	75	67.5	58	68.5	70.5	72	64	125
130	68.5	71	73	70	60.5	66.5	69.5	71	66	56.6	64.5	66.5	68	62.5	130
135	64.5	67	69	68	59.1	62.5	65	67	64	55.3	61	62.5	64	61	135
140	61	63	65	65.5	57.7	59	61.5	63.5	62.5	54.1	57.3	59.2	60.5	59.5	140
150	54	56.2	58	59.4	55.1	52.2	54.4	56.4	57.6	51.7	50.6	52.7	54	54.8	150
160	48.1	50.1	51.9	53.2	52.3	46.2	48.3	50.2	51.7	49.4	44.5	46.8	48.2	49	160
170	43	44.9	46.6	47.8	49	40.9	43.1	44.9	46.2	47.1	38.9	41.4	43.1	43.9	170
180	38.3	40.3	42	43.1	44.4	36.2	38.3	40.2	41.4	42.4	34.1	36.5	38.5	39.4	180
190	34.1	36	37.8	38.9	40.2	31.9	33.9	35.9	36.9	37.9	29.9	32.1	34.2	35.2	190
200		32.1	33.8	35.1	36.3	28.1	30	31.8	32.9	33.9	26	28.1	30.1	31.4	200
210		28.5	30.2	31.3	32.6		26.4	28.2	29.3	30.2	22.5	24.5	26.4	27.8	210
220		25.3	27	28.1	29.4		23.3	25	26	26.9	19.4	21.3	23.2	24.5	220
230			24	25.1	26.3		20.4	22	23	23.9	16.6	18.4	20.2	21.4	230
240				22.3	23.5			19.3	20.3	21.1		15.7	17.4	18.6	240
250				19.7	20.9			16.7	17.8	18.5		13.2	14.9	15.9	250
260				17.4	18.5			14.5	15.4	16.2		11	12.6	13.2	260
270					16.3				13.3	14			10.4	10.8	270
280					14.2					11.8				8.7	280
290										9.7				7.2	290
300										8.3				5.7	300

TAB 124244

Lifting heights on LF boom/jib combination Hauteur de levage en configuration LF

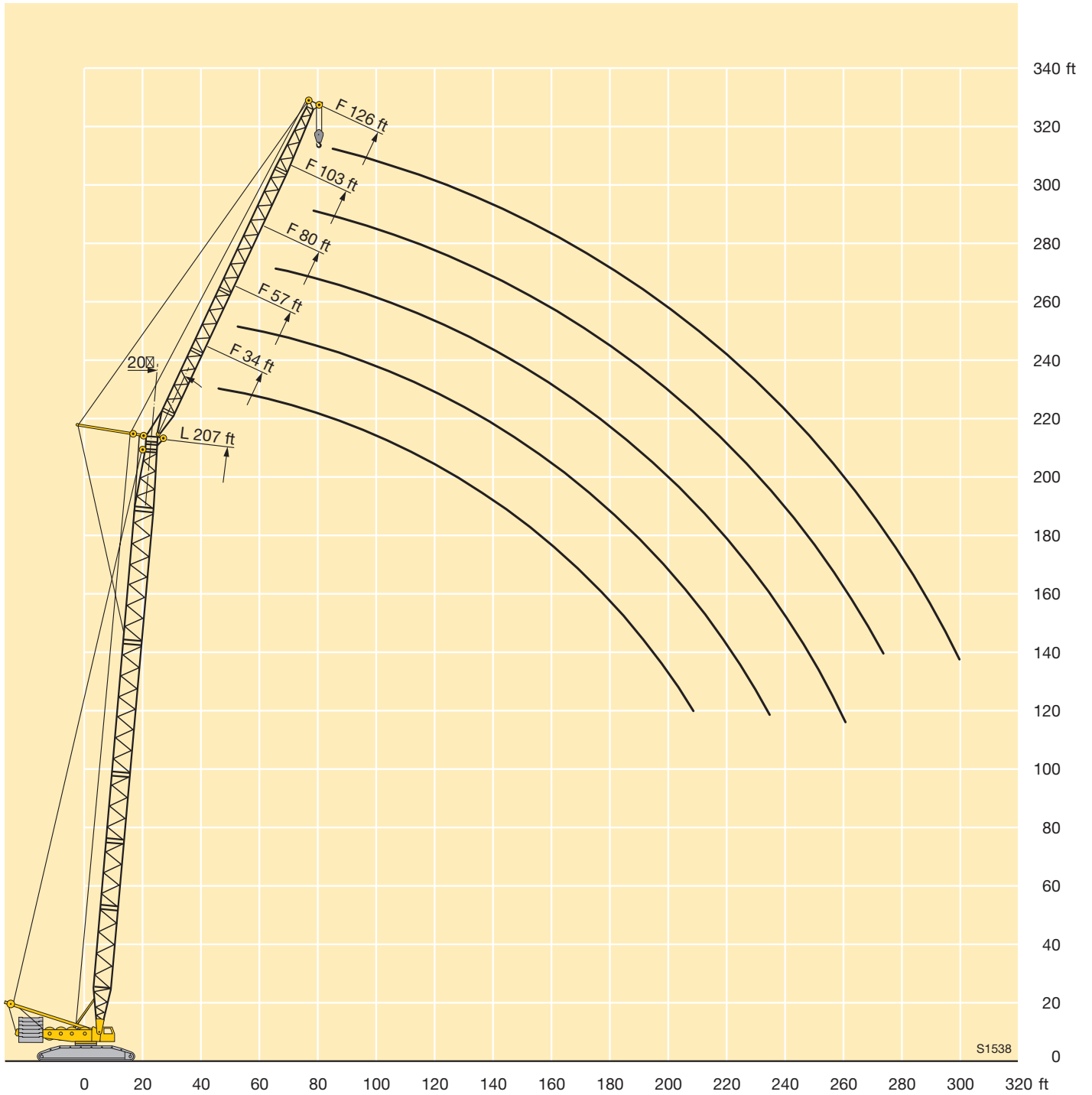

Lifting capacities on LN boom/jib combination

Forces de levage en configuration LN

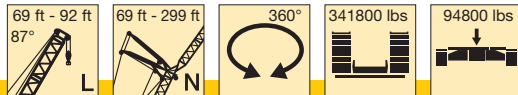

ft	69 ft											92 ft											ft	
	69 ft	92 ft	115 ft	138 ft	161 ft	184 ft	207 ft	230 ft	253 ft	276 ft	299 ft	69 ft	92 ft	115 ft	138 ft	161 ft	184 ft	207 ft	230 ft	253 ft	276 ft	299 ft		
40	284											276												40
45	267											260												45
50	250	232	213									244	222											50
55	232	218	204	182								229	210	195										55
60	214	205	195	175	156							213	199	187	162	145								60
65	193	195	186	168	151							196	190	179	157	141								65
70	176	179	175	160	146	123						179	181	171	152	137	115							70
75	159	164	163	153	141	120	102					163	170	164	147	133	112	93.5						75
80		151	150	146	136	117	100	83.5	68				157	155	142	129	109	91.5	79					80
85		139	138	138	131	114	97.5	81.5	67				145	146	137	125	107	89.5	77.5					85
90		131	129	128	126	111	95.5	80	65.5	54.2			135	136	132	121	104	87.5	76	63				90
95		121	120	120	119	108	93	78.5	64.5	53.3	40.3		126	126	125	117	101	85.5	74.5	61.5	51.3	39.2		95
100			112	112	111	105	91	76.5	63	52.4	39.5			118	118	113	98.5	83.5	72.5	60.5	50.4	38.5	100	
105			105	105	104	102	88.5	75	62	51.4	38.7			110	110	109	96	81.5	71	59.4	49.5	37.7	105	
110			100	99	98	97	86	73.5	60.5	50.5	37.9			105	104	103	93	79.5	69.5	58.3	48.7	36.9	110	
115			94.5	93.5	92.5	91.5	84	71.5	59.5	49.6	37.2			99	97.5	97	90.5	77.5	68	57.2	47.8	36.2	115	
120				88	87.5	86.5	81.5	70	58.2	48.6	36.4				92	92	88	75.5	66.5	56	46.9	35.4	120	
125				83.5	83	82	79.5	68	57	47.7	35.6				87	87	85	73.5	65	54.9	46	34.7	125	
130				80	78.5	77.5	76.5	66.5	55.8	46.8	34.8				83.5	82.5	81.5	71	63.5	53.7	45.2	33.9	130	
135				75	75	74	73	65	54.5	45.8	34				78.5	78.5	77.5	69	62	52.6	44.3	33.2	135	
140				69.5	71	70.5	69.5	63	53.3	44.9	33.2				72.5	74.5	74	67	60	51.4	43.4	32.4	140	
150					65	64	63	59.8	50.8	43	31.7					68	67	63	57.1	49.2	41.7	30.9	150	
160						58.4	57.4	56.1	48.4	41.2	30.1						61	59	53.9	46.9	40	29.4	160	
170						54.1	52.5	51.5	45.9	39.3	28.5						56.7	54.9	50.8	44.6	38.2	27.9	170	
180						49.1	48.1	47.3	43.5	37.5	27						51.1	50.5	47.7	42.3	36.5	26.4	180	
190							44.6	43.5	41	35.6	25.4							46.5	44.5	40	34.7	24.9	190	
200							41	40.2	38.6	33.7	23.8							42.5	41.4	37.7	33	23.3	200	
210								37.6	36.1	31.8	22.3								38.3	35.4	31.3	21.8	210	
220								34.8	33.4	30	20.7									35.1	33.2	29.5	20.3	220
230									31	28.1	19.1										30.9	27.8	18.8	230
240									28.8	26.2	17.6										28.6	26	17.3	240
250										24.4	16											24.3	15.8	250
260										22.5	14.4											22.6	14.3	260
270										20.7	12.9											20.8	12.8	270
280											11.3												11.2	280

TAB 124110

Lifting capacities on LN boom/jib combination

Forces de levage en configuration LN

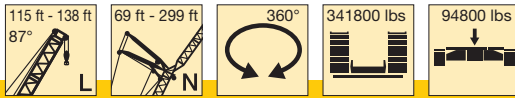

ft	115 ft												138 ft												ft			
	69 ft	92 ft	115 ft	138 ft	161 ft	184 ft	207 ft	230 ft	253 ft	276 ft	299 ft	69 ft	92 ft	115 ft	138 ft	161 ft	184 ft	207 ft	230 ft	253 ft	276 ft	299 ft						
40	272											243											40					
45	257											232											45					
50	242	217										222	195										50					
55	228	207	188									211	187	169									55					
60	213	197	182	158								200	180	163	143								60					
65	198	188	175	153								189	173	158	138								65					
70	181	180	168	148	133	110						178	165	152	134	121							70					
75	165	170	162	144	130	108	89.5					166	158	147	130	117	100	84					75					
80		159	154	139	126	105	87.5	74.5				151	141	126	114	97.5	82	70					80					
85		147	146	134	122	103	85.5	73				143	135	122	111	95.5	80.5	69					85					
90		136	137	130	119	100	83.5	72	60.5			136	130	118	108	93	78.5	67.5	56.4				90					
95		126	128	125	115	97.5	82	70.5	59.6	50.2		128	124	114	104	90.5	77	66	55.4	48			95					
100			120	119	111	95	80	69	58.6	49.3	37.3		118	109	101	88	75	64.5	54.4	47.1	36.2		100					
105			113	113	107	92.5	78	67.5	57.5	48.5	36.5		113	105	98	86	73.5	63.5	53.4	46.3	35.4		105					
110			107	107	104	90	76	66	56.4	47.7	35.8		107	101	94.5	83.5	71.5	62	52.3	45.5	34.7		110					
115			99	101	99.5	87.5	74.5	64.5	55.3	46.8	35.1		100	97	91.5	81	70	60.5	51.3	44.6	34		115					
120			89.5	95.5	94.5	85	72.5	63.5	54.3	46	34.4		92.5	93	88	78.5	68	59.2	50.3	43.8	33.3		120					
125				91	89.5	82.5	70.5	62	53.2	45.1	33.6			89	85	76.5	66.5	57.8	49.3	42.9	32.5		125					
130				85.5	85.5	80	68.5	60.5	52.1	44.3	32.9			84.5	81.5	74	64.5	56.5	48.3	42.1	31.8		130					
135				79	81.5	77.5	67	59.1	51	43.5	32.2			79	78.5	71.5	63	55.1	47.3	41.3	31.1		135					
140				72.5	77.5	75	65	57.7	50	42.6	31.5			73.5	75.5	69	61	53.7	46.3	40.4	30.4		140					
150					69	69.5	61	54.8	47.8	40.9	30				69	64.5	57.5	51	44.3	38.7	28.9		150					
160						64	57.4	52	45.7	39.3	28.6					59.8	54	48.2	42.3	37.1	27.5		160					
170						57.7	53.6	49.2	43.5	37.6	27.1					55	50.5	45.5	40.3	35.4	26		170					
180						50.6	49.9	46.4	41.4	35.9	25.7					50.3	46.9	42.7	38.2	33.7	24.6		180					
190							46.1	43.5	39.2	34.2	24.2						43.4	40	36.2	32	23.1		190					
200							41.9	40.7	37.1	32.5	22.8						39.9	37.2	34.2	30.3	21.7		200					
210								37.9	34.9	30.9	21.3							34.5	32.2	28.7	20.2		210					
220									35.1	32.8	29.2	19.9							31.7	30.2	27	18.8		220				
230										30.6	27.5	18.4								28.2	25.3	17.3		230				
240										28.5	25.8	17									26.1	23.6	15.9		240			
250											24.1	15.5										21.9	14.4		250			
260												22.5	14.1										20.3	13		260		
270													20.8	12.6										18.6	11.5		270	
280																										10.1		280

TAB 124110

Lifting capacities on LN boom/jib combination

Forces de levage en configuration LN

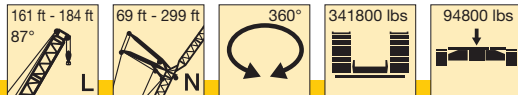

ft	161 ft											184 ft											ft	
	69 ft	92 ft	115 ft	138 ft	161 ft	184 ft	207 ft	230 ft	253 ft	276 ft	299 ft	69 ft	92 ft	115 ft	138 ft	161 ft	184 ft	207 ft	230 ft	253 ft	276 ft	299 ft		
50	212											179												50
55	202	177	156									172	152											55
60	191	170	151	132								164	146	132	114									60
65	181	163	146	128								157	141	128	111									65
70	170	157	141	124	112							150	136	124	108	97								70
75	160	150	136	121	109	95.5						142	131	120	105	94.5	82.5							75
80		143	131	117	106	93.5	79						125	116	102	92.5	81	68						80
85		136	126	113	103	91	77.5						120	112	99	90	79	66.5						85
90		129	121	110	101	89	75.5	65	52.1				115	108	96	87.5	77	65	56.3					90
95		122	116	106	97.5	86.5	74	63.5	51.2	45.8			110	104	93.5	85	75	63.5	55.2	46.9				95
100		114	111	103	95	84.5	72	62.5	50.3	45	34		104	100	90.5	82.5	73.5	62.5	54.1	46.1	39.5			100
105			106	99	92	82	70.5	61	49.5	44.2	33.3			96	87.5	80	71.5	61	53	45.3	38.8	30.9		105
110			101	95.5	89	80	69	59.8	48.6	43.5	32.6			92	84.5	78	69.5	59.4	51.9	44.5	38.1	30.2		110
115			95.5	92	86	77.5	67	58.5	47.7	42.7	32			88	81.5	75.5	67.5	58	50.8	43.7	37.4	29.6		115
120			90.5	88	83.5	75.5	65.5	57.3	46.9	41.9	31.3			84	78.5	73	66	56.6	49.7	42.9	36.7	29		120
125			84.5	80.5	73	64	56	46	41.1	30.6					75.5	70.5	64	55.1	48.6	42.1	36	28.4		125
130			81	77.5	70.5	62	54.7	45.1	40.3	30					72.5	68	62	53.7	47.5	41.3	35.4	27.7		130
135			77	74.5	68.5	60.5	53.4	44.2	39.6	29.3					69.5	65.5	60	52.3	46.4	40.5	34.7	27.1		135
140			73.5	72	66	58.8	52.1	43.4	38.8	28.6					66.5	63.5	58.3	50.9	45.3	39.7	34	26.5		140
150				66	61.5	55.4	49.6	41.6	37.2	27.3					58.5	54.6	48	43.2	38.1	32.6	25.2			150
160				59.9	57.1	52.1	47	39.9	35.7	26					53.6	50.8	45.1	41	36.4	31.3	23.9			160
170				52.5	52.5	48.7	44.5	38.1	34.1	24.6					48.8	47.1	42.3	38.8	34.8	29.9	22.7			170
180					48	45.3	41.9	36.4	32.6	23.3						43.3	39.4	36.6	33.2	28.5	21.4			180
190						42	39.3	34.6	31	22							36.6	34.4	31.6	27.1	20.2			190
200						38.6	36.8	32.9	29.4	20.6							33.7	32.2	30	25.8	18.9			200
210							34.2	31.1	27.9	19.3								30	28.4	24.4	17.6			210
220							31.7	29.4	26.3	18								27.8	26.8	23	16.4			220
230							29.1	27.6	24.8	16.6								25.6	25.2	21.7	15.1			230
240								25.9	23.2	15.3									23.6	20.3	13.9			240
250									21.6	14										18.9	12.6			250
260									20.1	12.7										17.6	11.3			260
270									18.5	11.3										16.2	10.1			270
280										10											8.8			280

TAB 124110

Lifting capacities on LN boom/jib combination

Forces de levage en configuration LN

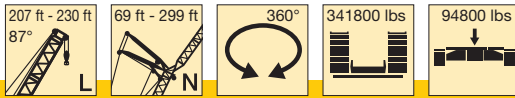

ft	207 ft											230 ft							ft		
	69 ft	92 ft	115 ft	138 ft	161 ft	184 ft	207 ft	230 ft	253 ft	276 ft	299 ft	92 ft	115 ft	138 ft	161 ft	184 ft	207 ft	230 ft		253 ft	
50	159																				50
55	153	135										115									55
60	147	130	116									112	97.5								60
65	142	126	113									108	95								65
70	136	122	110	97								105	92.5	82							70
75	131	118	107	94.5	82.5							102	90	80	69.5						75
80	125	114	104	92	81	71.5	61.5					98.5	87.5	77.5	68.5	59.2					80
85	119	109	101	89.5	79	69.5	60					95	85	75.5	67	58.1					85
90		105	98	87	77	68	58.9	49.8				91.5	82.5	73.5	65.5	56.9	50.9				90
95		101	95	84.5	75	66.5	57.6	48.9	43.6			88.5	80	71.5	64	55.8	49.8	43.6	37		95
100		97	92	82	73	65	56.4	47.9	42.8	37.3		85	77.5	69.5	62.5	54.6	48.8	42.7	36.3	100	100
105			89	79.5	71.5	63.5	55.1	47	42.1	36.6	28.7		75	67	61	53.5	47.8	41.9	35.7	105	105
110			86	77	69.5	62	53.9	46	41.3	36	28.1		72.5	65	59.5	52.3	46.8	41.1	34.9	110	110
115			83	74.5	67.5	60	52.6	45.1	40.5	35.3	27.5		70	63	58.1	51.2	45.8	40.2	34.2	115	115
120			80	72	65.5	58.7	51.3	44.1	39.8	34.7	26.9		67.5	61	56.6	50	44.8	39.4	33.5	120	120
125				69.5	63.5	57.1	50.1	43.2	39	34	26.3			58.8	55.2	48.8	43.7	38.5	32.9	125	125
130				67	62	55.5	48.8	42.2	38.2	33.4	25.7			56.7	53.7	47.7	42.7	37.7	32.1	130	130
135				64	59.9	53.9	47.6	41.3	37.5	32.7	25.1			54.6	52.3	46.5	41.7	36.9	31.4	135	135
140				61.5	57.9	52.4	46.3	40.3	36.7	32.1	24.5			52.5	50.8	45.4	40.7	36	30.7	140	140
150					54.1	49.2	43.8	38.4	35.1	30.7	23.4				47.9	43.1	38.7	34.3	29.3	150	150
160					50.3	46.1	41.3	36.5	33.6	29.4	22.2				45	40.8	36.6	32.7	27.9	160	160
170					46.5	42.9	38.7	34.6	32.1	28.1	21				42.1	38.5	34.6	31	26.5	170	170
180						39.8	36.2	32.7	30.5	26.8	19.8					36.1	32.6	29.3	25.2	180	180
190							33.7	30.8	29	25.5	18.7						30.5	27.6	23.7	190	190
200							31.2	28.9	27.5	24.2	17.5						28.5	25.9	22.3	200	200
210								27	25.9	22.9	16.3							24.3	20.9	210	210
220									25.1	24.4	15.1							22.6	19.6	220	220
230										23.2	14							20.9	18.1	230	230
240											21.3	19	12.8						16.7	240	240
250												17.7	11.6							250	250
260													16.4	10.4						260	260
270														15.1	9.3					270	270
280															8.1					280	280
290																6.9				290	290
300																	5.7			300	300

TAB 124110

Lifting heights on LN boom/jib combination Hauteur de levage en configuration LN

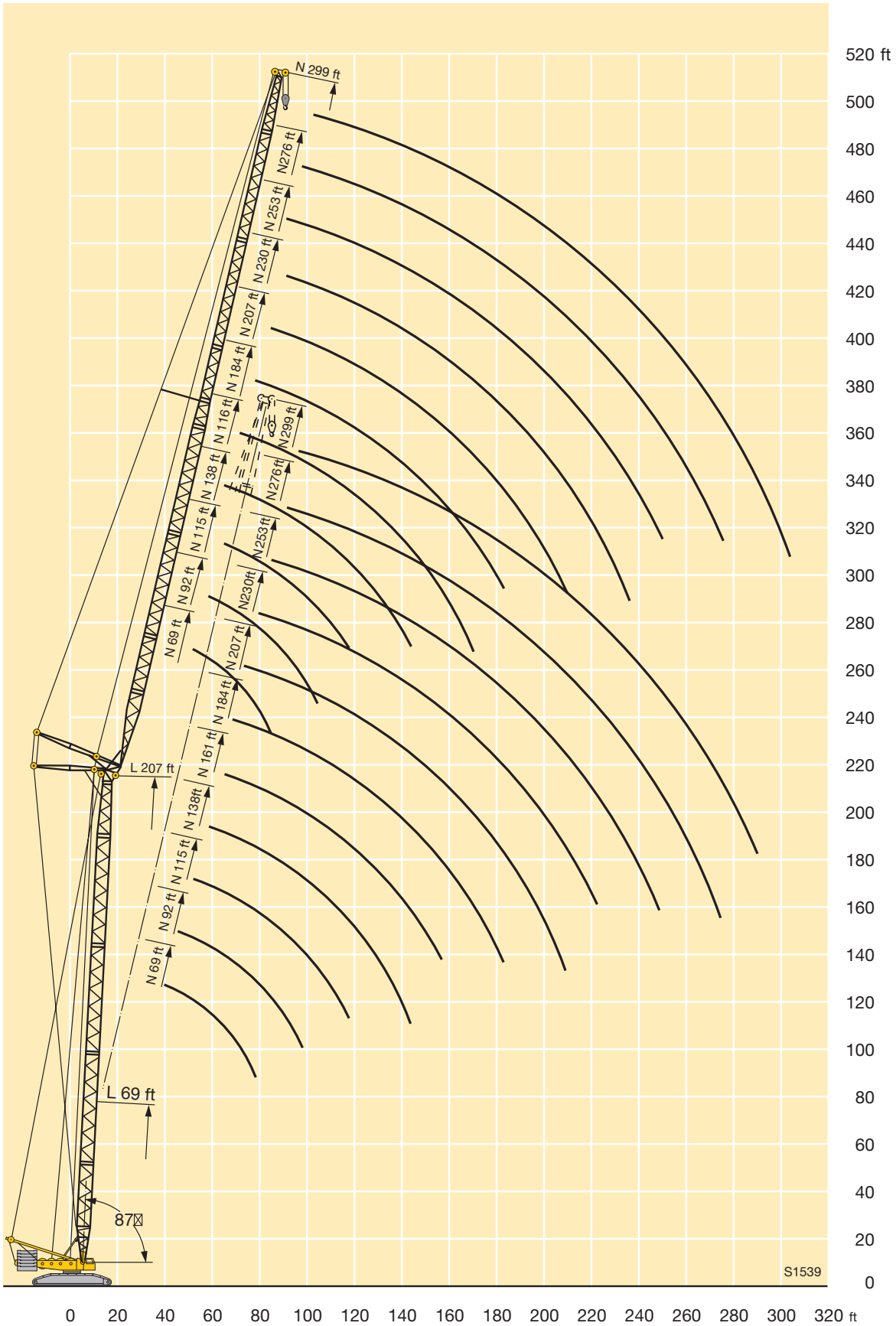

Lifting capacities on SL boom

Forces de levage à la flèche principale SL

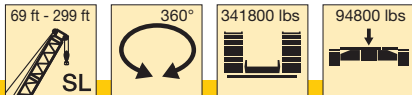

ft	69 ft	92 ft	115 ft	138 ft	161 ft	184 ft	207 ft	230 ft	253 ft	276 ft	299 ft	ft
15	772											15
16	772											16
17	762											17
18	747											18
19	713											19
20	680	664										20
21	650	635										21
22	623	608										22
23	597	583	571	558								23
24	575	562	550	539								24
26	532	520	509	499								26
28	497	486	476	466	440							28
30	464	453	444	435	408	381						30
32	436	426	417	406	381	357						32
34	411	401	393	380	357	335	317	299				34
36	387	379	371	356	335	315	299	283				36
38	367	358	351	335	317	298	283	268	255			38
40	346	339	332	317	300	283	269	255	243	230		40
45	296	294	290	277	263	249	238	226	216	205		45
50	256	254	252	246	235	222	213	202	193	184	176	50
55	223	221	219	218	210	200	191	182	174	166	159	55
60	196	195	193	192	190	180	173	165	158	150	144	60
65	176	174	172	171	170	164	158	150	144	137	131	65
70		157	155	154	153	150	145	138	132	126	120	70
75		143	141	140	139	137	133	127	122	116	111	75
80		131	129	127	126	124	123	117	112	106	102	80
85		120	118	117	116	114	113	108	104	98	94	85
90			109	108	107	104	103	101	96.5	91	87	90
95			102	99.5	98.5	96.5	95.5	93.5	89.5	84.5	80.5	95
100			94.5	92.5	91.5	89	88	86.5	83.5	78.5	75	100
105				86.5	85	82.5	81.5	80	78	73	69.5	105
110				81	79.5	77	76	74	73	68	64.5	110
115				76	74.5	72	70.5	69	68	63.5	60	115
120				71.5	70	67.5	66	64	63	59.3	56	120
125					65.5	63	61.5	59.9	58.8	55.3	52.2	125
130					62	59.3	57.9	56.1	54.9	51.7	48.6	130
135					58.6	56	54.5	52.6	51.4	48.4	45.4	135
140					55.5	52.8	51.2	49.3	48.1	45.2	42.4	140
150						47.1	45.5	43.4	42	39.1	36.5	150
160							40.4	38.1	36.5	33.5	31	160
170							35.9	33.4	31.8	28.7	26	170
180							32	29.4	27.7	24.4	21.5	180
190								25.9	24.1	20.6	17.3	190
200									20.9	17.3	13.8	200
210									18	14.3	11.5	210
220									15.5	12	9.4	220
230										9.9	7.5	230
240										7.9		240

TAB 124065

Lifting heights on SL boom Hauteur de levage à la flèche principale SL

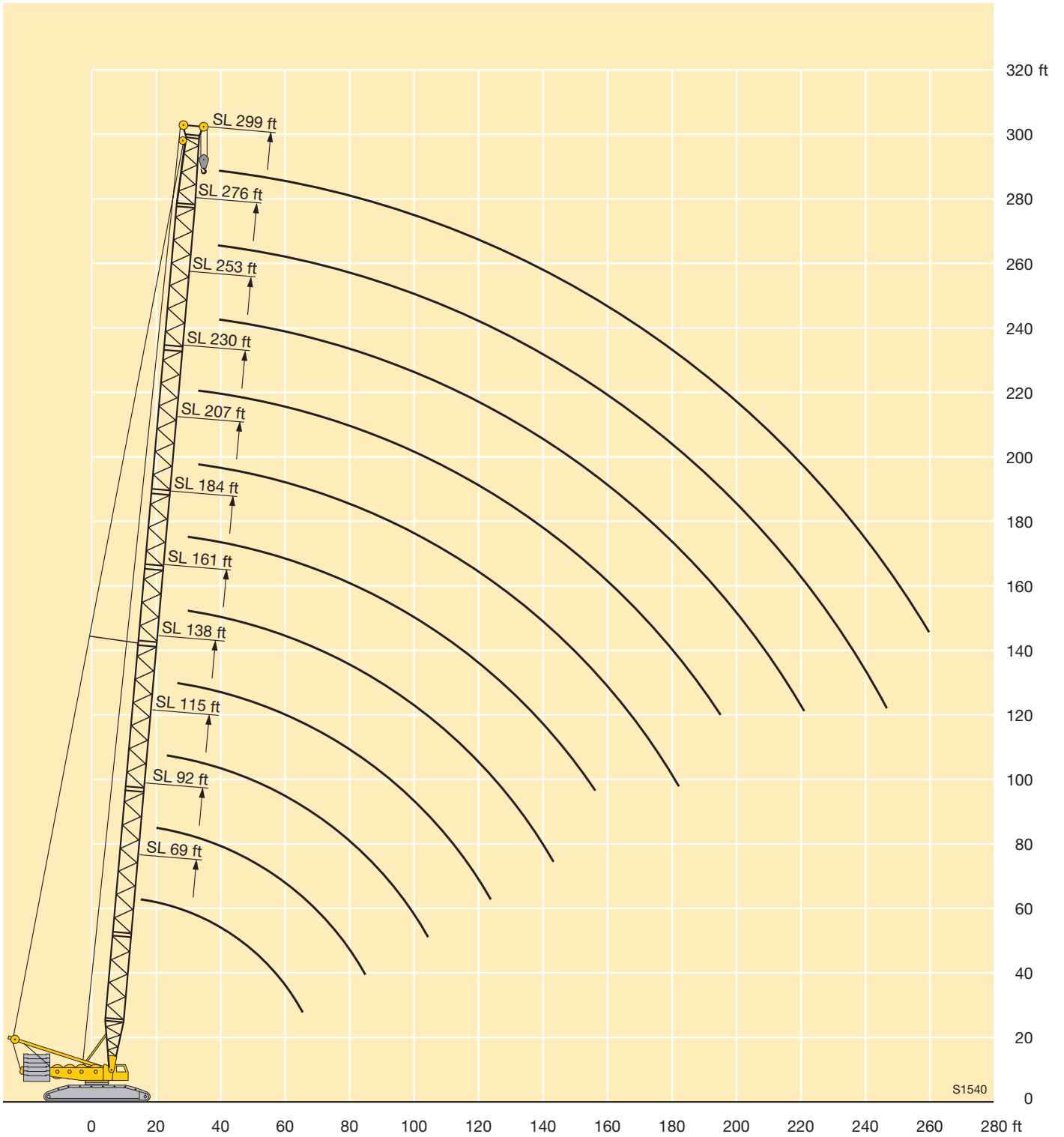

Lifting capacities on SLD boom/derrick combination

Forces de levage en configuration SLD

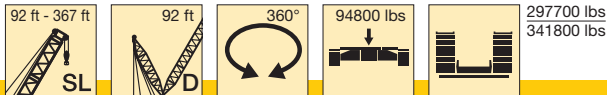

ft	92 ft	115 ft	138 ft	161 ft	184 ft	207 ft	230 ft	253 ft	276 ft*	299 ft*	322 ft*	344 ft*	367 ft*	ft	
23		583	571											23	
24		562	551											24	
26		520	510											26	
28	495	485	476	466										28	
30	461	453	444	434	448									30	
32	430	425	417	405	420									32	
34	400	398	400	400	394	375	356							34	
36	371	371	370	371	370	354	336							36	
38	347	347	346	346	345	335	319	306						38	
40	325	325	324	324	323	318	303	291	269					40	
45	280	280	278	278	277	277	269	259	247					45	
50	246	245	243	243	241	241	239	233	224	215	201			50	
55	218	216	214	214	212	212	211	209	203	195	187	173	150	55	
60	195	193	191	190	188	188	186	186	184	178	171	164	149	60	
65	176	174	172	171	169	168	167	166	166	162	156	150	144	65	
70	160	158	156	155	152	152	150	149	150	147	144	138	133	70	
75	147	144	142	141	138	138	136	135	135	132	131	126	123	75	
80	135	133	130	129	126	125	123	122	122	119	118	115	113	80	
85	125	122	120	118	115	114	113	111	111	108	107	104	104	85	
90		113	111	109	106	105	103	102	101	98.5	97	94	94.5	90	
95		106	103	101	98	97	95	93.5	92.5	90	88.5	85.5	85.5	95	
100		98.5	95.5	93.5	90.5	89.5	87.5	86	85	82	80.5	77.5	77.5	100	
105			89	87	84	82.5	80.5	79	78	75	73.5	70.5	70.5	105	
110			83	81	78	77	74.5	73	72	69	67	64.5	64	110	
115			78	76	73	71.5	69	67.5	66.5	63.5	61.5	58.6	58.3	115	
120			73.5	71	68	66.5	64	62.5	61.5	58.4	56.4	53.4	53	120	
125				66.5	63.5	62	59.5	57.9	56.6	53.6	51.6	48.6	48.1	125	
130				62.5	59.4	57.6	55.3	53.7	52.3	49.3	47.2	44.3	43.7	130	
135				59.2	55.8	54	51.6	50	48.5	45.5	43.4	40.4	39.8	135	
140				55.9	52.4	50.5	48	46.4	44.9	41.9	39.7	36.7	36.1	140	
150					46.3	44.2	41.6	39.9	38.3	35.3	33	30.1	29.2	150	
160						38.7	36	34.3	32.5	29.5	27.2	24.2	22.8	160	
170							34	31.2	29.4	27.5	24.5	22.1	19.1	16.5	170
180							30	27.1	25.1	23.2	20.1	17.7	14.7	12.6	180
190								23.4	21.4	19.3	16.2	13.7	10.8	9.2	190
200									18	15.8	12.7	10.2		200	
210									15	12.6	9.5			210	
220									12.4	9.9	6.7			220	
230										7.4				230	

* erectable only with derrick ballast / n'est relevable qu'avec contrepoids derrick

TAB 124073 / 124074

Lifting heights on SLD boom/derrick combination

Hauteur de levage en configuration SLD

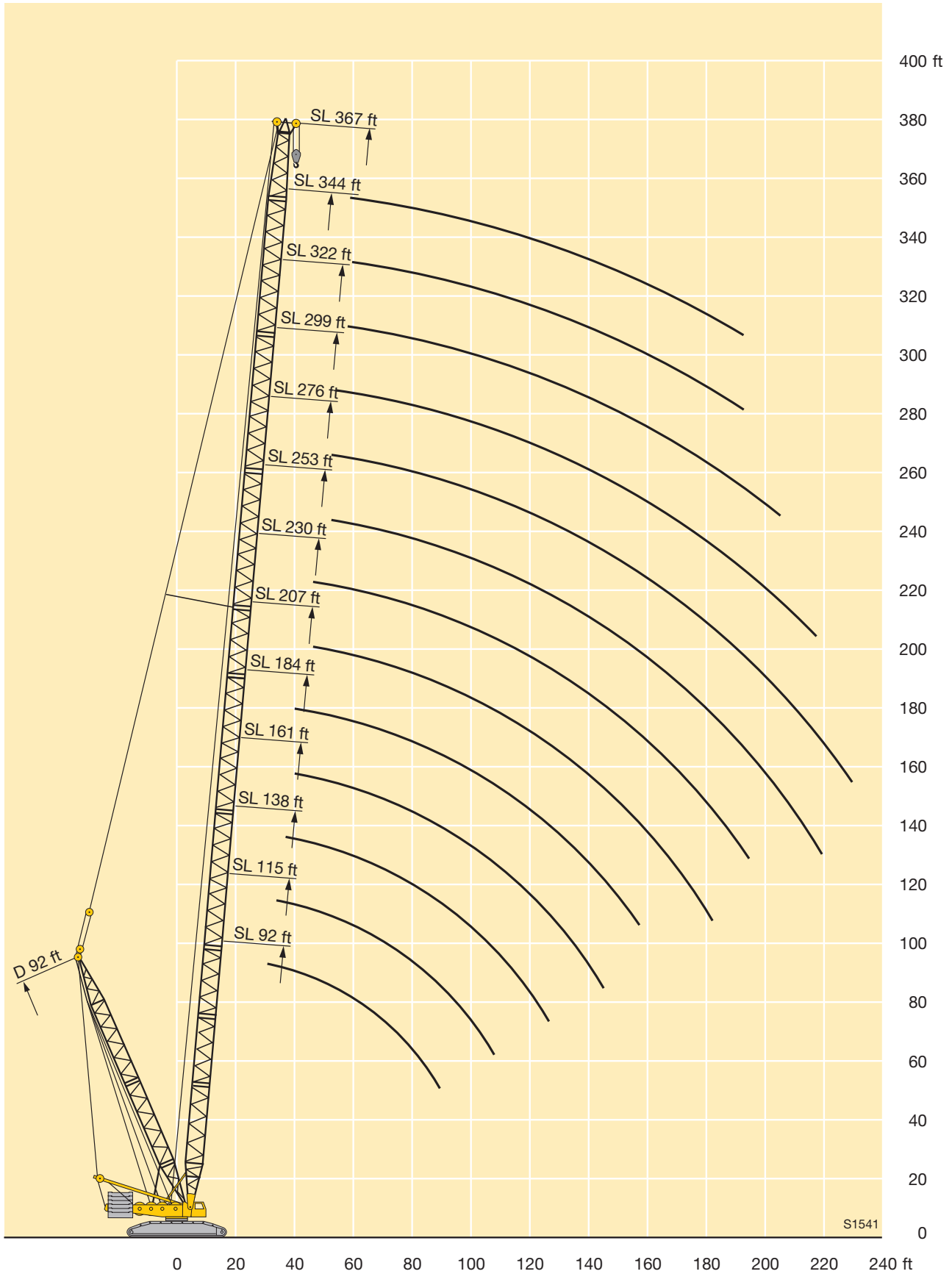

S1541

Lifting capacities on SLDB/BW boom/derrick combination

Forces de levage en configuration SLDB/BW

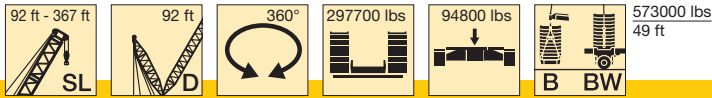

ft	92 ft	115 ft	138 ft	161 ft	184 ft	207 ft	230 ft	253 ft	276 ft	299 ft	322 ft	344 ft	367 ft	ft
21	772													21
22	766													22
23	758	745	719											23
24	756	742	717											24
26	750	737	713	657										26
28	745	733	710	655										28
30	741	729	706	652	605									30
32	736	725	703	649	603	531	476							32
34	733	721	700	647	601	530	475							34
36	729	717	697	644	599	529	475	404						36
38	726	714	694	642	598	528	474	404						38
40	715	711	691	640	596	528	474	404	330					40
45	648	704	679	635	593	526	473	404	325	277	238			45
50	579	678	653	616	579	524	472	404	320	276	238			50
55	520	634	627	594	559	518	471	401	316	275	238	201	167	55
60	470	578	601	570	534	505	468	396	313	274	237	199	165	60
65	426	528	565	549	510	482	459	388	309	272	236	196	162	65
70	394	486	520	516	497	465	442	378	303	270	234	194	160	70
75	366	450	481	480	477	447	422	367	297	266	231	192	158	75
80	340	418	448	444	451	429	403	357	289	260	227	188	154	80
85	316	390	422	414	419	411	388	347	283	253	222	182	150	85
90		367	398	390	391	394	375	338	276	247	217	177	146	90
95		346	377	369	368	374	359	328	270	242	212	173	142	95
100		327	358	349	347	352	341	318	264	236	208	168	138	100
105			339	332	329	331	324	308	258	231	203	164	134	105
110			322	319	312	314	312	299	252	225	199	159	130	110
115			307	304	298	298	299	288	246	220	196	155	127	115
120			294	290	286	286	286	276	241	216	192	152	124	120
125				278	275	268	272	264	235	211	188	148	120	125
130				267	264	257	259	254	229	206	184	144	116	130
135				256	253	248	248	244	222	202	180	141	113	135
140				245	242	239	237	235	214	197	176	137	109	140
150					223	221	217	219	199	187	169	130	103	150
160						204	201	203	184	178	161	123	97	160
170						192	187	188	171	169	154	116	91	170
180						179	175	175	162	159	147	110	86	180
190							164	162	155	150	141	105	81.5	190
200								150	147	140	135	100	77.5	200
210								141	139	131	128	96	73.5	210
220								132	134	124	121	92	70	220
230									126	116	114	88.5	67	230
240									119	109	107	86	64	240
250										103	101	83.5	62	250
260										97.5	95	81	59.7	260
270											90	79.5	57.5	270
280												78	55.5	280
290												76	53.9	290
300												72	52.7	300
310													51.7	310
320													50.4	320
330													48.9	330
340													47.6	340

TAB 147008 / 147014

Lifting heights on SLDB/BW boom/derrick combination
Hauteur de levage en configuration SLDB/BW

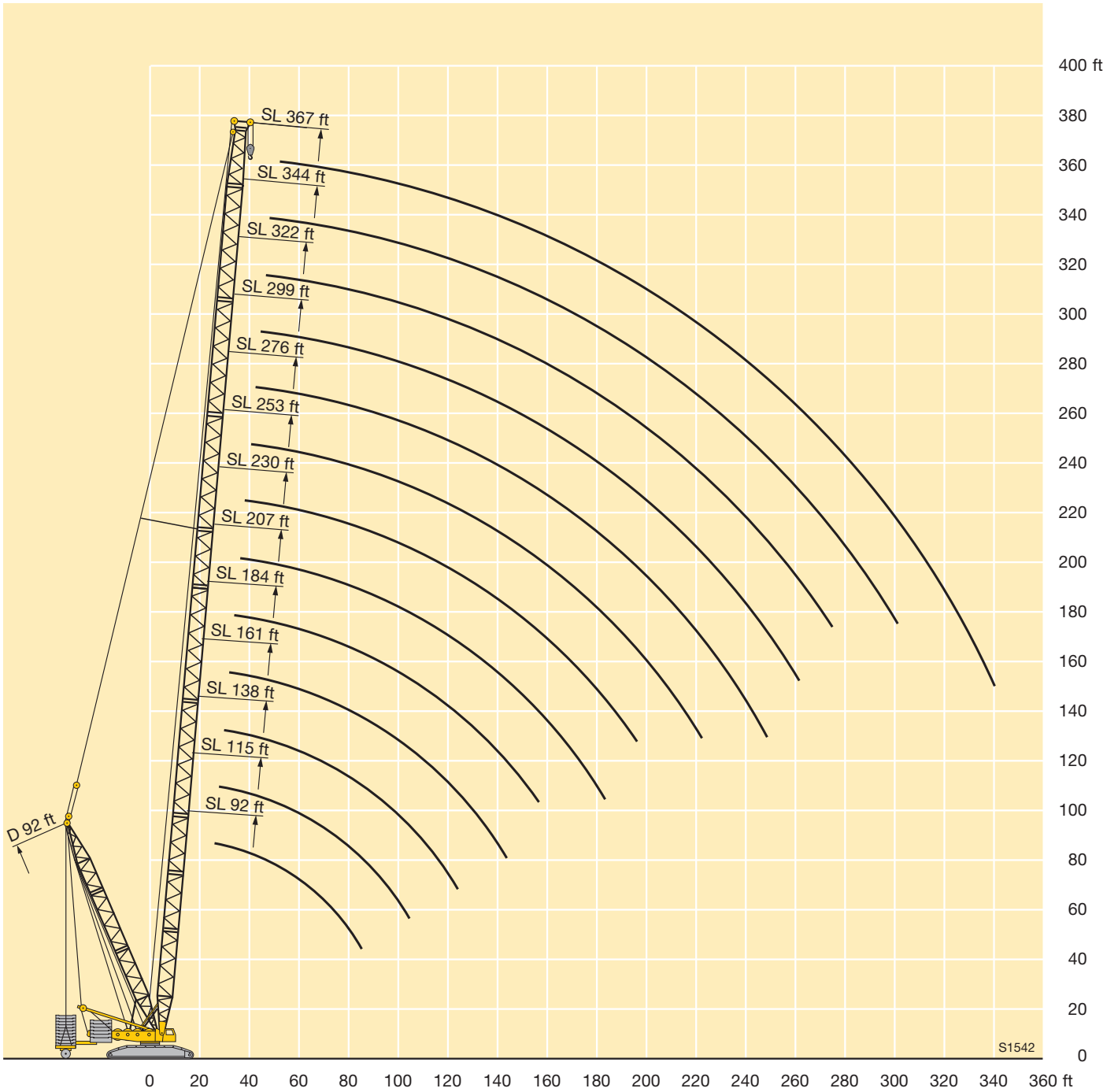

Lifting capacities on SLN boom/jib combination

Forces de levage en configuration SLN

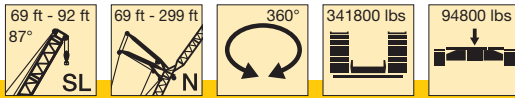

ft	69 ft											92 ft											ft				
	69 ft	92 ft	115 ft	138 ft	161 ft	184 ft	207 ft	230 ft	253 ft	276 ft	299 ft	69 ft	92 ft	115 ft	138 ft	161 ft	184 ft	207 ft	230 ft	253 ft	276 ft	299 ft					
40	285											287												40			
45	277	257	233									287	265											45			
50	260	244	223									272	254											50			
55	244	229	212	188								252	239	217										55			
60	227	216	201	182	153							230	221	208	180	147								60			
65	207	205	191	175	151	126						210	204	196	178	145	122							65			
70	188	190	183	168	148	125						191	189	183	173	142	121							70			
75	168	174	172	162	145	124	101					175	175	171	165	140	119	98						75			
80		160	160	155	141	123	100	83.5	69				161	159	154	138	118	96.5	80.5					80			
85		149	147	147	137	121	99	83	68	58.1			149	148	145	136	117	95.5	80	66.5				85			
90		138	136	137	132	120	97.5	82	67.5	57.7			139	138	137	132	116	94.5	79	65.5				90			
95		126	126	127	126	117	96.5	81	66.5	57.1	45		130	129	128	126	115	93.5	78	65	55.2	43.8		95			
100			119	118	118	114	95.5	80.5	65.5	56.5	44.3			121	120	119	113	92.5	77.5	64	54.7	43.2	100				
105			112	109	111	109	94.5	79.5	65	55.9	43.6			114	113	112	110	91.5	76.5	63.5	54.1	42.5	105				
110			105	103	104	103	93.5	79	64	55.4	42.9			107	106	106	104	90.5	76	62.5	53.7	41.9	110				
115			98	97.5	97	97.5	92	78	63.5	54.9	42.3			102	101	100	99	89.5	75.5	62	53.2	41.3	115				
120				92.5	91	92	89.5	77.5	63	54.4	41.7				95.5	94.5	93.5	88.5	74.5	61.5	52.7	40.7	120				
125				87.5	86	86.5	85.5	77	62	53.9	41.2				90.5	90	89	87	74	60.5	52.3	40.2	125				
130				83	82	81.5	81	76	61.5	53.5	40.6				86.5	85.5	84.5	83.5	73	60	51.9	39.7	130				
135				76.5	78.5	77.5	77	73.5	60	53	40.1				80.5	81.5	81	80	72	59	51.4	39.2	135				
140				70	74.5	73.5	73	71	58.7	52.5	39.6				74.5	78	77	76	71	57.7	50.9	38.7	140				
150					67.5	67	65.5	64.5	56.1	51.3	38.5					71	70.5	69	67.5	55.3	50	37.7	150				
160						61	59.6	58.3	53.5	49.9	37.2						64.5	63	63	52.8	48.8	36.5	160				
170						55.9	54.9	52.7	50.8	48	35.3						58.8	58	56.6	50.4	47.1	34.8	170				
180						49.6	50.5	48.7	46.9	45.6	33.4						52.5	53.4	52.3	48	45.3	33	180				
190							46.4	45.1	43.4	42	31.6							49	48.4	45.5	43.3	31.3	190				
200							41.6	41.6	40.2	38.2	29.9							44.1	44.7	42.6	40.8	29.6	200				
210								38.2	37.2	35.3	28.3								41.1	39.5	37.6	28.0	210				
220									35	34.3	26.2									37.7	36.5	34.9	26.1	220			
230										31.6	30.2	24.2									33.6	32.3	24.2	230			
240										28.6	27.8	22.3										30.5	29.8	22.2	240		
250											25.5	20.4											27.3	20.4	250		
260												23.4	18.6											25.1	18.6	260	
270													20.1	16.9											21.6	16.9	270
280																										15.6	280

TAB 124154

Lifting capacities on SLN boom/jib combination

Forces de levage en configuration SLN

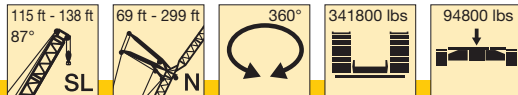

ft	115 ft											138 ft											ft	
	69 ft	92 ft	115 ft	138 ft	161 ft	184 ft	207 ft	230 ft	253 ft	276 ft	299 ft	69 ft	92 ft	115 ft	138 ft	161 ft	184 ft	207 ft	230 ft	253 ft	276 ft	299 ft		
40	286											272												40
45	285	259										267	233											45
50	264	247										249	227											50
55	240	231	209									230	217	193										55
60	221	212	203	172								211	203	187	160									60
65	204	196	188	170	138	115						196	188	180	158	129								65
70	189	183	176	167	136	115						183	176	169	155	128								70
75	175	171	164	159	134	114	94					171	165	159	150	126	107	88						75
80		160	154	150	132	113	93	77.5					155	149	144	125	106	87.5	73.5					80
85		148	145	141	130	112	92	77	63.5				146	140	136	123	105	86.5	73	60				85
90		138	137	133	127	111	91	76	63				137	133	129	121	104	85.5	72	59.7				90
95		129	128	126	122	110	90	75.5	62	53			129	126	122	117	103	84.5	71.5	59.1	50.2			95
100			120	120	116	109	89	74.5	61.5	52.5	41.9			120	116	112	102	84	70.5	58.4	49.8	39.9	100	
105			113	113	111	106	88	74	61	52	41.3			113	110	107	101	83	70	57.7	49.3	39.4	105	
110			107	106	105	101	87.5	73.5	60	51.5	40.7			107	105	102	98	82.5	69.5	57.1	48.9	38.9	110	
115			101	101	100	97	86.5	73	59.6	51.1	40.1			101	100	97.5	94.5	81.5	69	56.6	48.5	38.4	115	
120			94	95.5	94.5	92.5	85	72.5	59.1	50.6	39.6			95.5	95	93.5	90	80.5	68	56	48.1	37.9	120	
125				90.5	90	88.5	84	71.5	58.6	50.2	39				90	89.5	86.5	79.5	67.5	55.5	47.7	37.4	125	
130				86.5	85.5	84	82	71	58	49.8	38.5				86	85	83	79	67	54.9	47.4	36.9	130	
135				80.5	81.5	80.5	79	70	57.3	49.4	38				81.5	81.5	79.5	76.5	66.5	54.3	47	36.5	135	
140				74.5	78	77	75.5	69	56.4	49	37.6				77	77.5	76	73.5	66	53.7	46.7	36.1	140	
150					71.5	70	69	66	54.4	48	36.6					71	70	68	63.5	52.1	45.8	35.2	150	
160						64.5	63.5	62	52.1	46.8	35.6						64	62	60.5	50.1	44.8	34.3	160	
170						59.5	58.5	57.2	49.7	45.1	34.2						59.3	57.4	55.6	48.2	43.5	33.2	170	
180						52.7	54.2	52.9	47.5	43.4	32.5						54.7	53.2	51.4	46.2	42	31.6	180	
190							50.2	49.1	45.1	41.8	30.8							49.5	47.7	44	40.5	30	190	
200							45	45.7	42.6	40	29.2							45.1	44.3	41.8	39	28.5	200	
210								42.7	40.1	38	27.6								41.4	39.5	37.2	27	210	
220								38	37.8	35.9	25.9								38.8	37.1	35	25.4	220	
230									35.1	33.8	24									34.8	32.7	23.6	230	
240									31.3	31.7	22.1									31.8	30.5	21.8	240	
250										29.6	20.3										28.5	20.1	250	
260										26.4	18.6										26.7	18.4	260	
270										22.2	16.9										23	16.8	270	
280											15.6												15.5	280

TAB 124154

Lifting capacities on SLN boom/jib combination

Forces de levage en configuration SLN

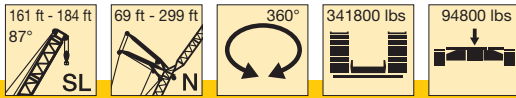

ft	161 ft												184 ft												ft
	69 ft	92 ft	115 ft	138 ft	161 ft	184 ft	207 ft	230 ft	253 ft	276 ft	299 ft	69 ft	92 ft	115 ft	138 ft	161 ft	184 ft	207 ft	230 ft	253 ft	276 ft	299 ft			
45	240											218											45		
50	232											215											50		
55	219	200	176									207	185										55		
60	203	191	171	147								195	180	160	137								60		
65	188	181	165	145	120							181	173	155	135	112							65		
70	176	169	160	141	119							169	163	150	132	111							70		
75	165	159	153	138	117	99.5						159	153	145	129	110	93.5						75		
80		149	144	135	116	98.5	82					144	139	126	108	92.5	77.5						80		
85		141	136	131	114	97.5	81	68	56.5			136	131	123	107	91.5	76.5	64.5					85		
90		134	129	125	113	97	80	67.5	56.1			129	124	120	105	91	76	64					90		
95		127	122	118	111	96	79.5	66.5	55.6	47.2		123	118	114	104	90	75	63	52.9				95		
100		121	116	112	108	95	78.5	66	55	46.8	37.9	117	112	109	102	89.5	74.5	62.5	52.4	44.5			100		
105			111	107	104	94.5	78	65.5	54.4	46.4	37.4		107	104	99.5	88.5	73.5	62	51.9	44.1	35.7		105		
110			106	102	99	93.5	77	65	53.9	46	36.9		103	99.5	95.5	87	73	61.5	51.4	43.7	35.2		110		
115			101	98	95	90.5	76.5	64.5	53.4	45.7	36.4		98.5	95	91.5	85.5	72.5	61	50.9	43.3	34.8		115		
120			95.5	94	91	87	75.5	64	52.9	45.3	36		94.5	91	87.5	83.5	71.5	60.5	50.4	43	34.3		120		
125				90	87	83.5	74.5	63.5	52.5	45	35.5				87.5	84	81	71	60	50	42.7	33.9	125		
130				86	83.5	80	74	63	52	44.6	35.1				84	80.5	78	70	59.7	49.5	42.3	33.5	130		
135				82	80.5	77	72.5	62.5	51.5	44.3	34.7				81	77.5	75	69	59.1	49	42	33.1	135		
140				78.5	77	74	70.5	62	51	44	34.3				77.5	74.5	72	68	58.6	48.5	41.8	32.7	140		
150					70.5	68	66	61	49.8	43.3	33.5					68.5	66.5	63.5	57.5	47.3	41.1	32	150		
160					64	62.5	60.5	58.8	48.3	42.4	32.7					63	61	58.5	55.9	45.8	40.3	31.3	160		
170					56.3	57.7	55.7	54.4	46.6	41.5	31.8					58.5	56.4	53.8	52.5	44.2	39.6	30.4	170		
180						53.6	51.6	50.4	44.8	40.2	30.4						52.4	49.9	48.6	42.7	38.6	29.4	180		
190							48	46.7	42.9	39	28.9							46.3	45.1	41	37.5	28.1	190		
200							44.6	43.4	40.8	37.7	27.5							43.1	41.9	39.1	36.3	26.8	200		
210								40.5	38.4	36.2	26.2								39	36.9	35.1	25.5	210		
220								37.9	35.8	34.1	24.8									36.5	34.4	32.8	24.2	220	
230								33.7	33.5	32	23.1									33.7	32.1	30.5	22.7	230	
240									31.3	29.8	21.4										30	28.2	21	240	
250										27.8	19.7											25.9	19.5	250	
260										25.9	18.2											23.8	18	260	
270										23.2	16.7											22.3	16.5	270	
280											15.4												15.2	280	

TAB 124154

Lifting capacities on SLN boom/jib combination

Forces de levage en configuration SLN

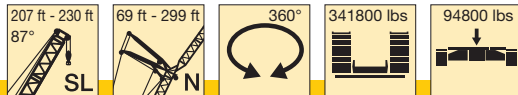

ft	207 ft											230 ft								ft	
	69 ft	92 ft	115 ft	138 ft	161 ft	184 ft	207 ft	230 ft	253 ft	276 ft	299 ft	92 ft	115 ft	138 ft	161 ft	184 ft	207 ft	230 ft	253 ft		
45	191																				45
50	189																				50
55	186	164										148									55
60	181	160	140									143	125								60
65	172	154	135	118								139	122	107							65
70	162	149	131	115								134	118	105							70
75	152	143	128	113	98							129	115	102	88.5						75
80	144	138	124	110	96	84	71					124	111	99	86.5	76.5					80
85	136	130	120	107	94	82.5	70.5	59.4				120	108	97	85	75	65.5				85
90		124	116	104	92.5	81	69.5	58.9				116	104	94	83	73.5	64				90
95		118	112	101	90.5	79.5	69	58.3	48.9			112	101	91.5	81.5	72	63	54.6	45.4		95
100		112	108	98.5	88.5	78.5	68.5	57.7	48.4	41		108	98	89	79.5	71	62	53.9	45.1		100
105			103	96	86	77	67.5	57.1	47.9	40.7	33.3		95	86.5	77.5	69.5	61	53.1	44.6		105
110			98.5	93	84	75.5	66.5	56.5	47.4	40.3	32.9		92.5	84	75.5	68	59.9	52.3	44.2		110
115			94.5	90.5	82	73.5	66	56	46.9	40	32.4		90	82	73.5	66.5	58.9	51.6	43.8		115
120			91	88	80	72	64.5	55.5	46.5	39.6	32		87.5	79.5	71.5	65	57.9	50.9	43.4		120
125				84.5	78	70.5	63.5	55	46.1	39.3	31.6			77.5	70	63.5	56.7	50.2	43		125
130				81	76.5	69	62	54.2	45.7	39	31.2			75.5	68	62	55.4	49.4	42.5		130
135				78	74	67.5	61	53.3	45.2	38.7	30.8			73.5	66.5	60.5	54.2	48.5	41.9		135
140				75	72	66	59.7	52.4	44.8	38.4	30.5			71.5	65	59.3	53.1	47.5	41.3		140
150					67	63	57.4	50.7	43.8	37.8	29.8				62	56.7	50.9	45.7	39.9		150
160					61.5	59	55	49.1	42.8	37	29.1				58.7	54.2	48.8	44	38.3		160
170					57.1	54.4	51.9	47.6	41.6	36.1	28.3				55	51.7	46.8	42.4	36.9		170
180						50.6	48.5	44.9	40.2	35	27.6					48.9	44.1	40.7	35.6		180
190							45.2	42.2	38.5	33.9	26.6						41.6	38.5	34.1		190
200							42	39.6	36.4	32.6	25.3						39.2	36.1	32.3		200
210								37	33.9	30.6	24.1							33.8	30.1		210
220								34.6	31.6	28.4	23							31.6	28		220
230								32.6	29.4	26.4	21.7							30.1	26		230
240									27.3	24.4	20.2								24.2		240
250										22.4	18.8										250
260										20.6	17.4										260
270										19.3	16.1										270
280											14.9										280
290											13.7										290
300											13										300

TAB 124154

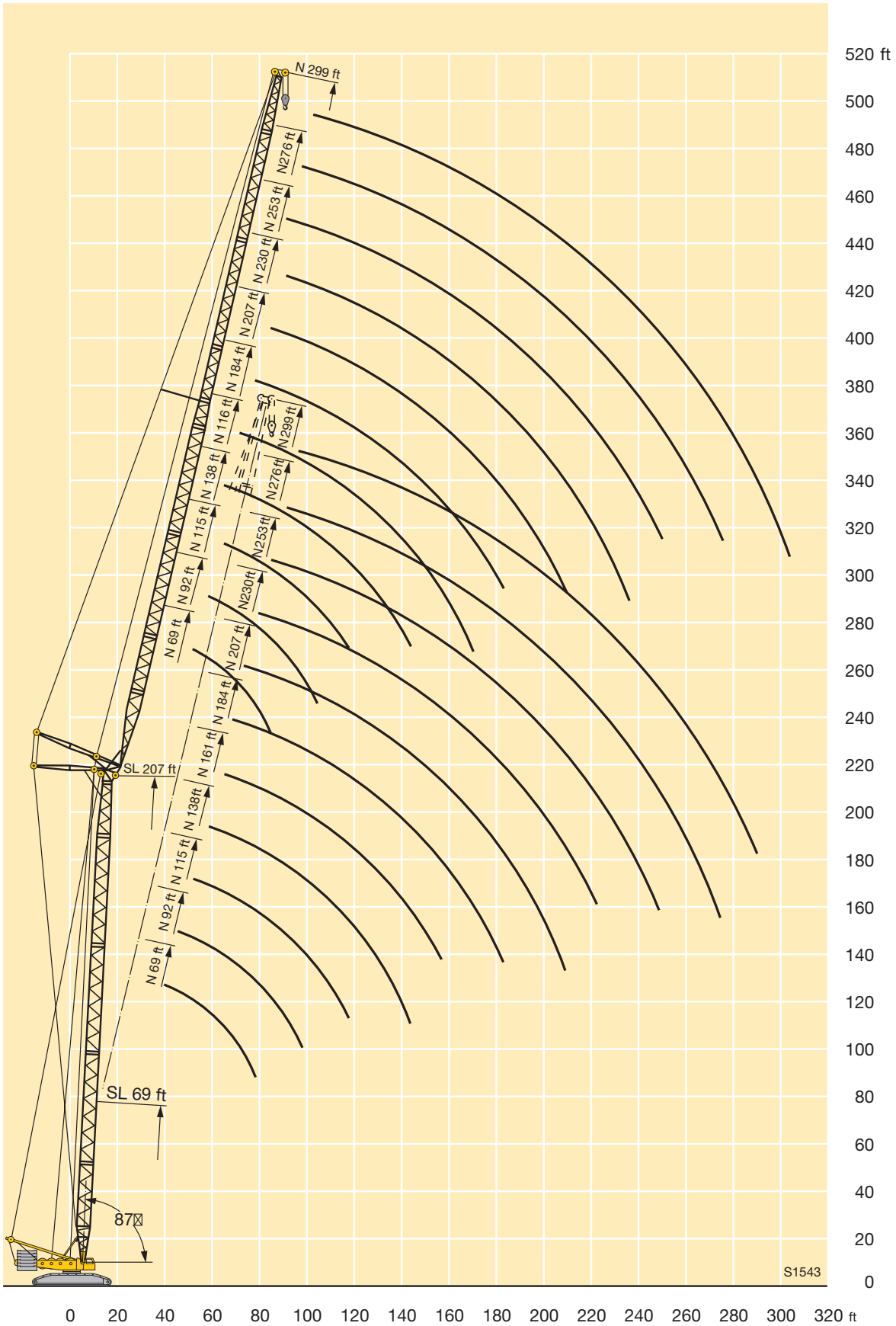

Lifting heights on SLN boom/jib combination Hauteur de levage en configuration SLN

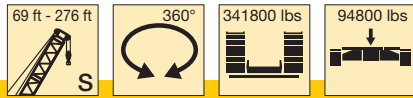

Lifting capacities on S boom

Forces de levage à la flèche principale S



 ft	69 ft	92 ft	115 ft	138 ft	161 ft	184 ft	207 ft	230 ft	253 ft	276 ft	 ft
15	772										15
16	772										16
17	762										17
18	746										18
19	712										19
20	679	663									20
21	649	634									21
22	621	608									22
23	595	583	596	581							23
24	574	562	574	561							24
26	531	519	531	519							26
28	495	506	496	485	474						28
30	462	473	464	453	443	420					30
32	434	444	436	425	417	394					32
34	427	419	410	401	392	370	348	319			34
36	403	395	387	378	370	348	329	310			36
38	382	375	367	359	350	330	311	295	271		38
40	363	356	349	340	331	312	295	280	265	239	40
45	322	315	309	301	291	275	261	248	236	222	45
50	281	278	275	268	259	246	234	222	211	201	50
55	246	245	243	238	232	221	210	200	190	182	55
60	217	216	215	212	209	199	190	181	172	164	60
65	194	193	192	189	188	182	173	165	157	150	65
70		174	173	171	169	166	159	151	144	137	70
75		159	157	155	153	151	146	139	132	126	75
80		145	144	141	140	138	134	128	122	116	80
85		134	132	129	128	126	124	118	112	107	85
90			122	119	118	116	114	110	104	99	90
95			113	111	109	107	105	102	97	92	95
100			106	103	101	98.5	96.5	95	90	85	100
105				95.5	94	91.5	89.5	87.5	83.5	79	105
110				89.5	87.5	85.5	83.5	81.5	78	73.5	110
115				84	82	79.5	77.5	75.5	72.5	68.5	115
120				79	77	74.5	72.5	70.5	67.5	63.5	120
125					72.5	70	67.5	65.5	63	58.8	125
130					68	65.5	63.5	61	58.5	54.4	130
135					64.5	62	59.7	57.4	54.6	50.6	135
140					61	58.3	56.1	53.8	50.9	46.9	140
150						52	49.6	47.2	44.1	40.1	150
160							44	41.3	38.1	34.1	160
170							38.9	36	32.9	28.8	170
180							34.6	31.6	28.4	24.1	180
190								27.7	24.2	19.7	190
200									20.4	15.8	200
210									17	12.8	210
220									14.3	10.6	220
230										8.6	230
240										6.8	240

TAB 124056 / 124057

Lifting heights on S boom Hauteur de levage à la flèche principale S

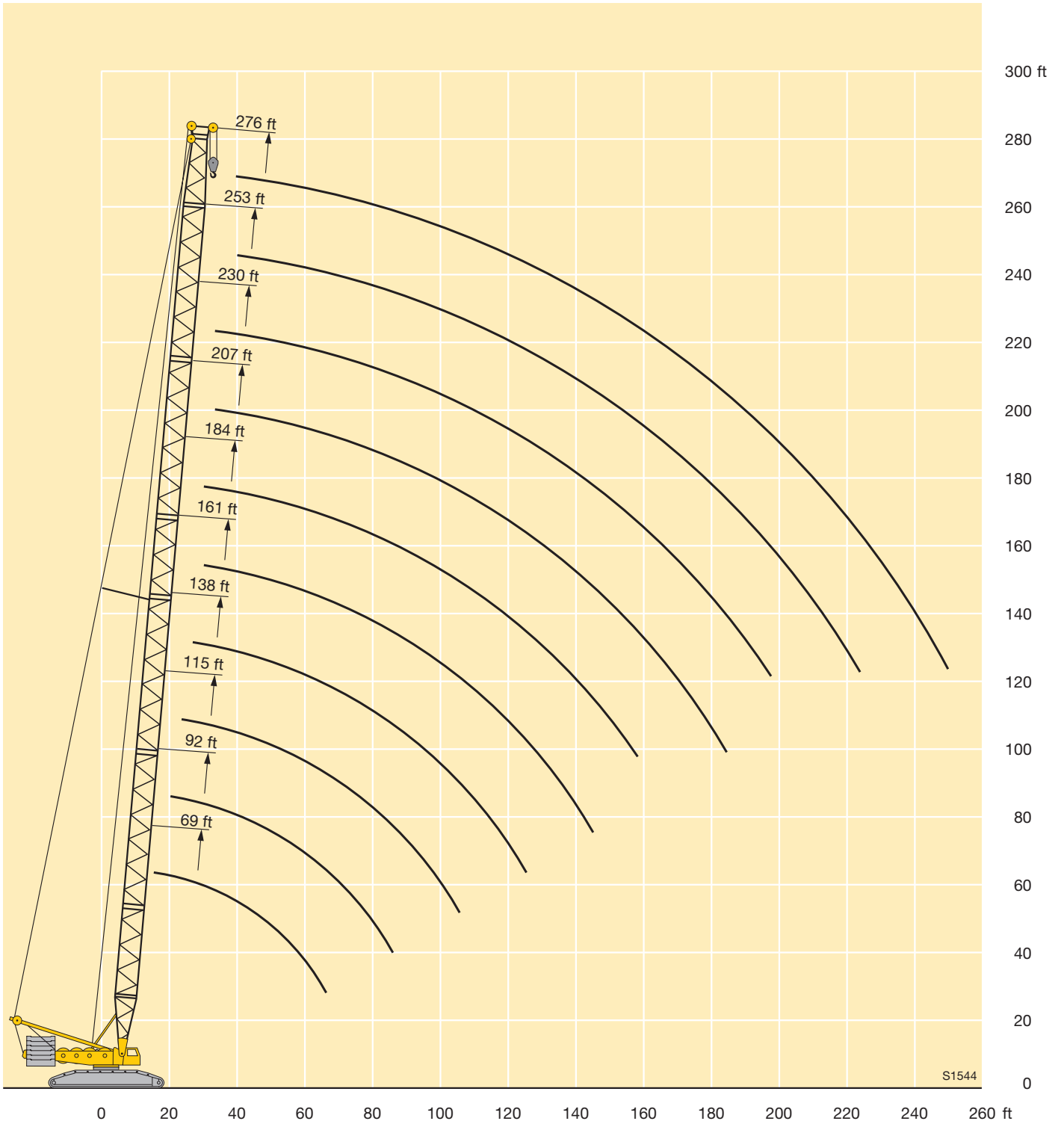

Lifting capacities on Sw boom

Forces de levage à la flèche principale Sw

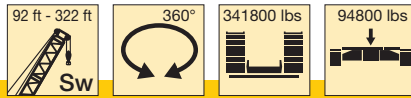

ft	92 ft	115 ft	138 ft	161 ft	184 ft	207 ft	230 ft	253 ft	276 ft	299 ft	322 ft	ft
20	397											20
21	397											21
22	397	397										22
23	397	397	397									23
24	397	397	397									24
26	397	397	397									26
28	397	397	397	397	328							28
30	397	397	397	395	319	292						30
32	393	397	385	390	309	281						32
34	387	391	366	379	299	271	243					34
36	367	380	397	365	289	261	238					36
38	397	368	360	352	280	252	234	241				38
40	365	359	352	339	272	244	230	239	220	197		40
45	325	319	314	301	252	224	221	232	216	185		45
50	286	283	280	269	233	206	213	219	207	180	160	50
55	251	251	249	242	216	190	204	202	194	176	158	55
60	222	221	220	219	201	176	192	184	177	170	155	60
65	199	199	197	195	187	163	176	169	162	157	149	65
70	181	180	179	177	174	152	163	156	150	145	138	70
75	165	164	163	161	160	141	151	144	138	134	128	75
80	151	151	149	147	146	130	140	134	128	124	119	80
85	140	139	138	135	134	120	130	125	119	116	110	85
90		129	128	125	124	112	121	116	112	108	103	90
95		120	119	117	115	106	112	109	104	101	96	95
100		112	111	109	108	101	104	102	98	95	90	100
105			104	102	100	95.5	96.5	95	92	89	84.5	105
110			98	95.5	94	91	90.5	88.5	86.5	83.5	79	110
115			92.5	90	88.5	86	84.5	83	81	79	74.5	115
120			87	85	83.5	81	79.5	77.5	76	74.5	70	120
125				80	79	76.5	74.5	73	71.5	70	66	125
130				76	74.5	72.5	70.5	68.5	67	66	62	130
135				72.5	71	68.5	66.5	64.5	63	62.5	58.4	135
140				69	67.5	65	63	61	59.5	58.8	54.8	140
150					61	58.6	56.6	54.6	52.9	52.2	48.1	150
160						53	51	48.9	47.2	46.3	42.2	160
170						48	46.1	44	42.2	41.1	37	170
180						42.4	42	39.8	37.8	36.6	32.5	180
190							38.4	36	33.8	32.5	28.3	190
200								32.4	30.2	28.8	24.5	200
210								29.3	26.9	25.4	21	210
220								26.5	24.1	22.4	17.8	220
230									21.5	19.6	15.1	230
240										17	12.9	240
250										14.6	11.2	250
260										13.1	9.6	260
270											8.2	270

TAB 124009 / 124010

Lifting heights on Sw boom Hauteur de levage à la flèche principale Sw

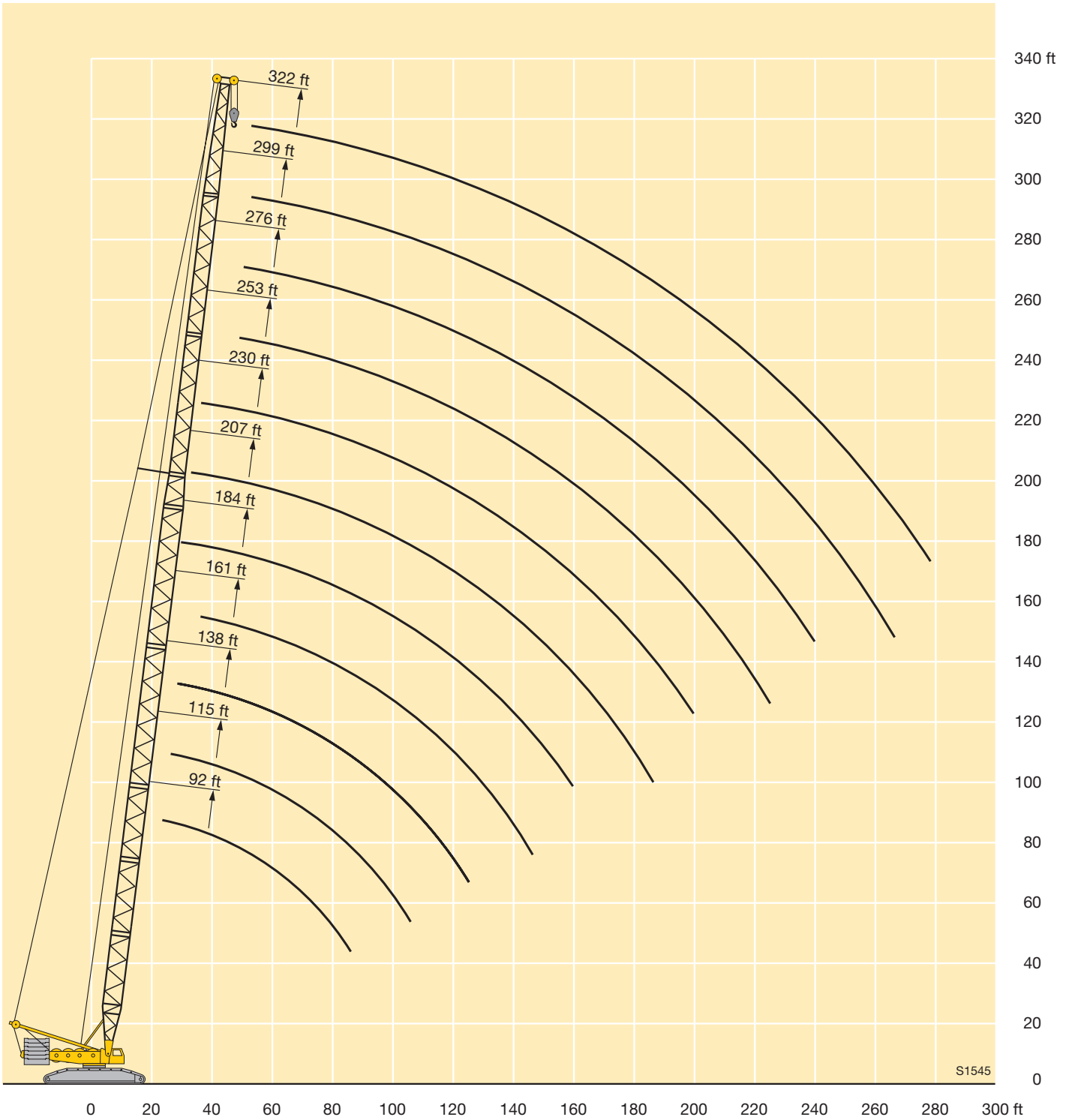

Lifting capacities on SwD boom/derrick combination

Forces de levage en configuration SwD

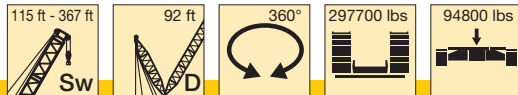

ft	115 ft	138 ft	161 ft	184 ft	207 ft	230 ft	253 ft	276 ft*	299 ft*	322 ft*	344 ft*	367 ft*	ft
28		397											28
30		397	397										30
32		397	397										32
34	390	389	385	365									34
36	377	375	366	348									36
38	354	352	347	330		313	282						38
40	332	330	328	328	328	309	280	241					40
45	287	285	282	282	283	279	266	233					45
50	252	250	247	247	247	247	242	225	213	178			50
55	224	221	219	218	218	218	216	210	203	175	167	128	55
60	201	198	195	195	195	194	192	190	185	171	164	128	60
65	182	179	176	175	175	174	173	170	168	164	158	128	65
70	166	163	160	159	159	158	156	154	151	152	146	128	70
75	152	149	146	145	145	144	142	140	137	138	134	125	75
80	140	137	134	133	133	132	130	127	125	126	122	119	80
85	130	126	123	123	122	121	119	116	114	115	111	110	85
90	121	117	114	114	113	112	110	107	105	105	102	101	90
95	113	109	106	105	105	104	102	99	96	96.5	93.5	92.5	95
100	105	102	99	98	97.5	96	94	91.5	88.5	89	86	84.5	100
105		95.5	92.5	91.5	90.5	89.5	87	84.5	81.5	82	79	77.5	105
110		89.5	86.5	85.5	85	83.5	81.5	78.5	75.5	76	73	71.5	110
115		84	81	80	79.5	78	76	73	70	70.5	67.5	66	115
120		79.5	76.5	75	74.5	73	71	68	65	65.5	62.5	60.5	120
125			72	70.5	70	68.5	66	63.5	60.5	60.5	57.6	55.9	125
130			68	66.5	65.5	64.5	62	59.1	56.2	56.4	53.3	51.6	130
135			64	63	62	60.5	58.2	55.3	52.5	52.6	49.5	47.7	135
140			61	59.4	58.6	57.1	54.7	51.7	48.9	49	45.9	44.1	140
150				53.1	52.2	50.8	48.2	45.3	42.3	42.4	39.3	37.4	150
160					46.7	45.2	42.6	39.6	36.6	36.7	33.5	31.6	160
170					41.9	40.3	37.6	34.6	31.6	31.6	28.5	26.5	170
180					37.8	36.1	33.4	30.3	27.3	27.3	24.1	21.9	180
190						32.4	29.6	26.5	23.4	23.3	20.2	17.5	190
200							26.2	23	19.9	19.8	16.6	13.7	200
210							23.1	19.9	16.8	16.6	13.4	11.1	210
220							20.5	17.2	14	13.8	10.6	8.4	220
230								14.7	11.5	11.2	8		230
240								12.7	9.2	8.8			240
250									7.1				250
260									5.2				260

* erectable only with derrick ballast / n'est relevable qu'avec contrepoids derrick

TAB 124048 / 124049

Lifting capacities on SwDB/SwDBW boom/derrick combination

Forces de levage en configuration SwDB/SwDBW

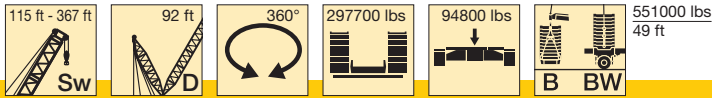

ft	115 ft	138 ft	161 ft	184 ft	207 ft	230 ft	253 ft	276 ft	299 ft	322 ft	344 ft	367 ft	ft
28	397	397											28
30	397	397	397										30
32	397	397	397										32
34	397	397	397	375									34
36	397	397	397	375									36
38	397	397	397	375	343	314	283						38
40	397	397	397	375	343	314	282	242					40
45	397	397	397	375	343	314	277	233					45
50	397	397	397	375	343	309	270	225	215	178			50
55	397	397	397	375	338	301	262	218	210	175	167	128	55
60	397	397	397	373	327	291	254	211	203	170	164	128	60
65	397	397	397	363	318	281	244	204	195	167	161	128	65
70	397	397	397	355	309	271	234	197	188	163	159	128	70
75	397	397	391	347	300	261	224	189	181	159	155	128	75
80	397	395	379	339	291	252	215	181	175	154	151	127	80
85	397	388	364	329	283	243	207	174	168	149	146	126	85
90	387	372	349	318	273	235	199	167	161	144	142	123	90
95	370	358	336	308	263	227	191	161	155	139	136	119	95
100	348	344	323	298	254	218	184	155	150	134	131	116	100
105		328	311	287	245	210	177	149	145	130	127	114	105
110		311	299	277	236	202	171	144	140	126	123	110	110
115		296	288	267	228	194	164	139	135	122	119	106	115
120		282	278	258	220	187	158	134	131	118	116	102	120
125			269	250	212	180	151	129	126	114	112	99	125
130			258	242	205	173	145	124	122	110	107	96.5	130
135			248	233	197	167	140	121	119	107	104	94.5	135
140			238	224	190	161	134	119	117	104	101	92	140
150				207	175	149	123	114	112	98.5	96.5	87.5	150
160					161	137	113	111	107	93	91	82.5	160
170					149	127	104	108	104	88	85	77.5	170
180					137	117	95.5	105	100	83.5	81	73.5	180
190						107	87.5	102	97.5	79.5	77.5	69.5	190
200							80	100	95	75	74	66.5	200
210							72.5	97.5	92.5	71	70.5	64	210
220							66	95	90.5	68	68	61.5	220
230								91.5	88	66.5	65.5	58.9	230
240								88	85.5	65.5	63.5	56.6	240
250									82.5	64.5	61.5	54.5	250
260									80	63	59.9	52.5	260
270										61.5	58.3	50.6	270
280											56.6	48.8	280
290											54.9	47	290
300											53.2	45.3	300
310												43.8	310

TAB 124007 / 124003

Lifting heights on SwDB/SwDBW boom/derrick combination
Hauteur de levage en configuration SwDB/SwDBW

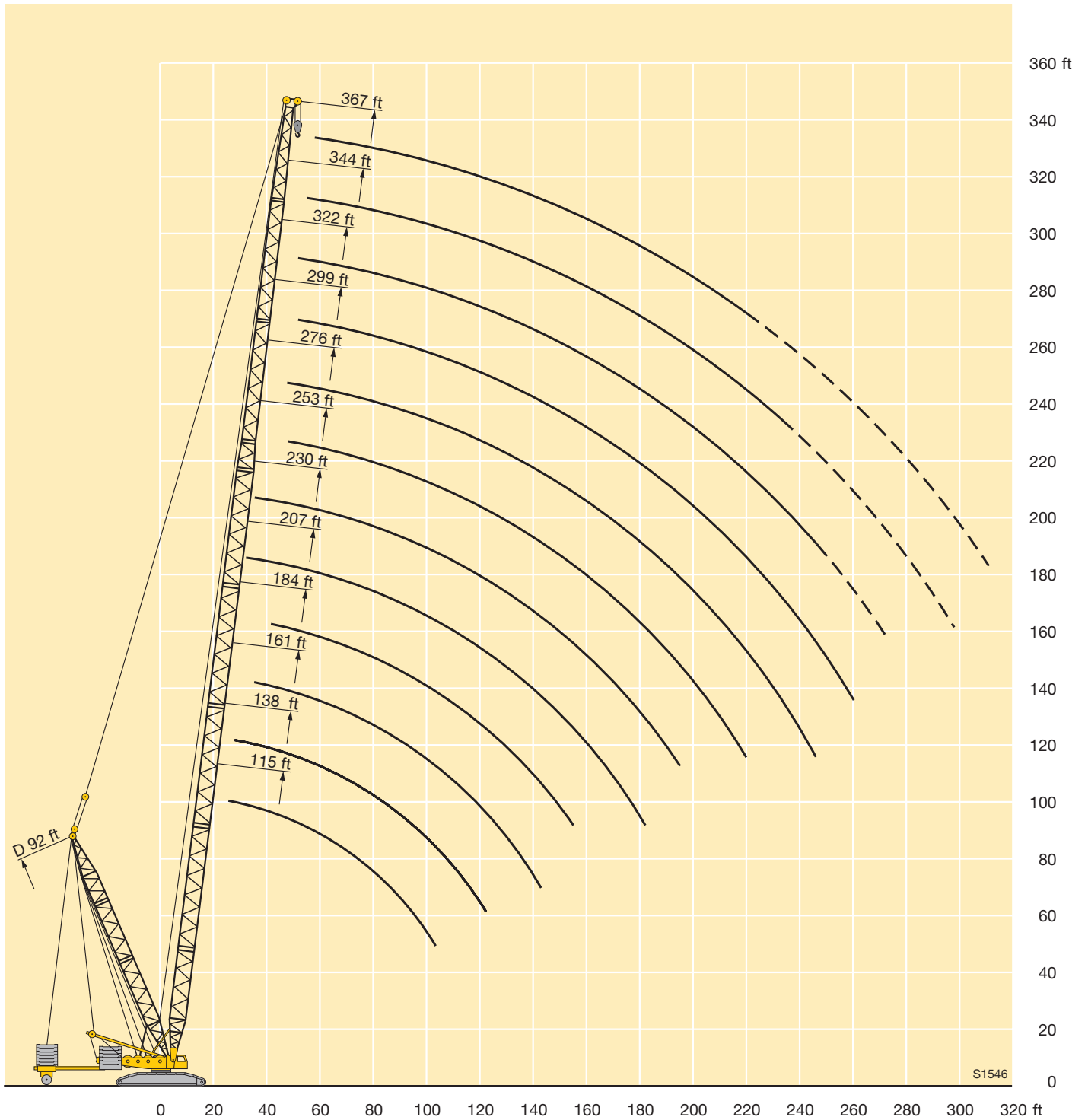

Lifting capacities on SD boom/derrick combination

Forces de levage en configuration SD

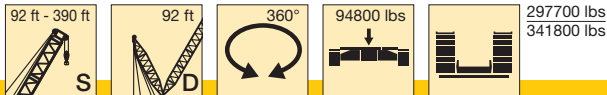

ft	92 ft	115 ft	138 ft	161 ft	184 ft	207 ft	230 ft	253 ft	276 ft	299 ft	322 ft	344 ft	367 ft	390 ft	ft
23		582	570												23
24		561	550												24
26		519	509												26
28	494	484	475	466											28
30	461	452	443	435	446										30
32	429	425	416	406	419										32
34	399	397	396	398	393	374	354								34
36	369	368	366	368	369	352	334								36
38	346	344	342	343	344	334	317	302							38
40	324	322	320	321	321	316	301	287	274						40
45	279	277	275	275	275	273	267	255	244						45
50	245	242	240	239	239	238	235	229	219	210	199				50
55	217	214	211	211	210	208	206	204	198	190	182	173	157	137	55
60	193	191	188	187	186	184	182	180	178	172	165	157	151	135	60
65	175	172	169	167	166	164	162	160	158	157	151	143	137	129	65
70	159	156	153	151	150	148	146	143	142	141	138	131	126	118	70
75	146	142	139	137	136	134	131	129	127	126	125	119	115	108	75
80	134	130	127	125	123	121	119	116	115	113	112	108	106	99	80
85	124	120	116	115	113	111	108	106	104	102	100	96.5	96	91	85
90		111	108	106	104	101	98.5	96	94	92.5	91	87	86.5	82.5	90
95		103	99.5	97.5	95.5	93	90.5	87.5	85.5	84	82	78.5	77.5	74	95
100		96.5	92.5	90	88	85.5	83	80	78	76	74.5	70.5	69.5	66	100
105			86	83.5	81	78.5	76	73.5	71	69	67	63.5	62.5	58.9	105
110			80	77.5	75.5	73	70	67.5	65	63	61	57.2	56	52.6	110
115			75	72.5	70	67.5	64.5	61.5	59.4	57.4	55.3	51.5	50.2	46.8	115
120			70.5	67.5	65	62.5	59.5	56.6	54.2	52.3	50.1	46.3	44.9	41.5	120
125				63	60.5	57.8	54.9	52	49.5	47.5	45.3	41.5	40	36.6	125
130				59.2	56.4	53.6	50.7	47.8	45.3	43.2	41	37.1	35.7	32.2	130
135				55.7	52.8	50	47	44	41.5	39.4	37.1	33.3	31.7	28.3	135
140				52.4	49.3	46.4	43.4	40.4	37.9	35.7	33.5	29.6	28	24.5	140
150					43.2	40.1	37	34	31.4	29.1	26.8	22.5	21.2	17.6	150
160						34.6	31.4	28.3	25.6	23.4	20.9	16.2	15.3		160
170						29.9	26.6	23.4	20.6	18.3	15.8	11.4	10.1		170
180						26	22.5	19.2	16.3	14	11.4				180
190							18.8	15.4	12.5	10.1					190
200								12							200
210								9							210
220								6.4							220

TAB 124052 / 124053

Lifting capacities on SDB/SDBW boom/derrick combination

Forces de levage en configuration SDB/SDBW

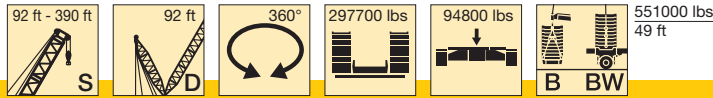

ft	92 ft	115 ft	138 ft	161 ft	184 ft	207 ft	230 ft	253 ft	276 ft	299 ft	322 ft	344 ft	367 ft	390 ft	ft
21	772														21
22	772														22
23	772	772	772												23
24	772	772	772												24
26	772	772	772	772											26
28	768	772	772	772											28
30	763	772	772	772	720										30
32	758	772	772	772	705	624	524								32
34	754	770	772	770	691	623	524								34
36	750	766	772	768	677	622	523	443							36
38	746	763	760	746	664	621	522	442							38
40	740	755	745	724	652	617	522	442	352						40
45	705	707	692	675	618	588	520	441	350	293	254				45
50	667	660	646	630	586	561	504	437	347	290	254				50
55	627	617	605	591	553	532	485	429	344	287	254	208	179	150	55
60	589	580	569	556	521	502	466	416	341	284	253	207	178	150	60
65	556	547	536	524	490	475	448	402	338	281	253	207	177	149	65
70	510	516	508	497	465	451	427	389	332	274	253	206	175	149	70
75	462	481	476	469	442	429	407	377	326	267	252	203	173	148	75
80	414	449	443	440	420	408	388	364	320	261	251	200	169	148	80
85	369	428	411	409	400	389	371	350	314	255	248	197	165	147	85
90		401	393	391	382	372	355	335	304	249	245	194	162	147	90
95		376	375	369	365	356	339	322	293	243	243	190	158	147	95
100		351	355	348	346	340	325	309	282	238	239	187	155	146	100
105			334	332	324	322	313	297	272	232	235	185	152	144	105
110			321	316	307	305	301	285	262	228	230	182	149	142	110
115			307	300	294	292	289	275	252	223	224	179	146	141	115
120			292	285	283	279	275	265	243	218	219	176	143	139	120
125				275	271	265	260	256	235	212	213	172	140	138	125
130				265	258	253	246	247	227	206	207	168	137	136	130
135				255	245	243	237	237	219	201	201	164	134	134	135
140				244	232	234	230	226	211	196	194	160	130	132	140
150					214	216	213	208	194	186	183	152	123	127	150
160						199	196	193	178	175	172	145	117	122	160
170						186	180	181	168	161	162	138	111	118	170
180						176	171	167	156	150	150	131	106	114	180
190							162	155	144	142	137	124	101	110	190
200								146	134	134	127	118	96	105	200
210								139	128	124	121	112	91.5	101	210
220								132	121	116	115	101	87	97.5	220
230									114	108	108	91	78.5	91.5	230
240									107	102	100	81.5	68.5	86	240
250										97.5	93	74	58.7	82	250
260										93.5	89	67	52.3	76	260
270											85.5	61	46.2	71	270
280												56.6	40.8	67	280
290												53.8	36.5	63	290
300												51.2	33.4	56.4	300
310													30.4	49.2	310
320													28.4	43.1	320
330														38.7	330
340														36.1	340

TAB 147004 / 147040

Lifting heights on SDB/SDBW boom/derrick combination

Hauteur de levage en configuration SDB/SDBW

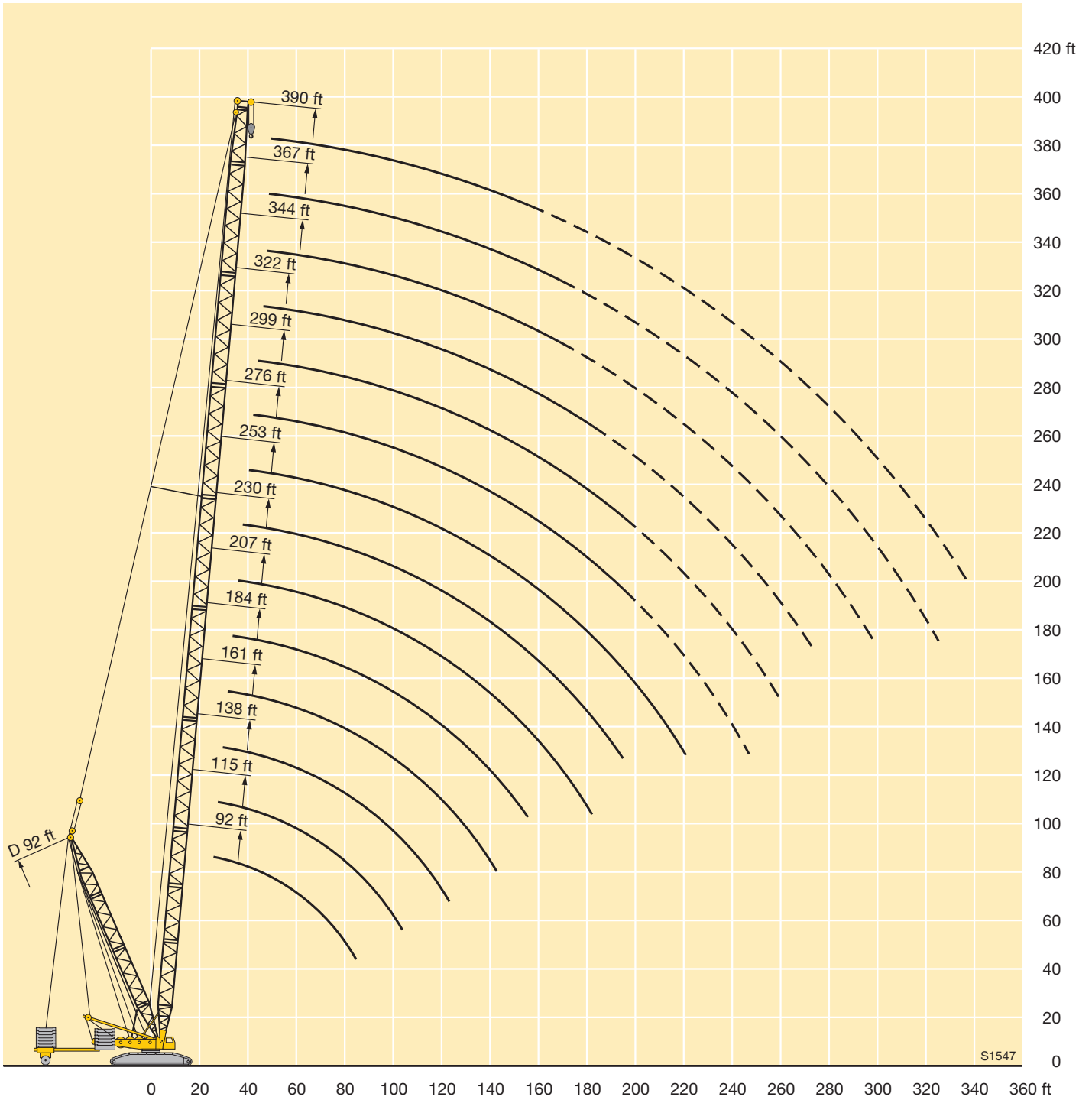

Lifting capacities on SW boom/jib combination

Forces de levage en configuration SW

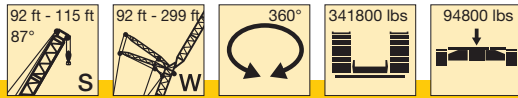

ft	92 ft										115 ft										ft
	92 ft	115 ft	138 ft	161 ft	184 ft	207 ft	230 ft	253 ft	276 ft	299 ft	92 ft	115 ft	138 ft	161 ft	184 ft	207 ft	230 ft	253 ft	276 ft	299 ft	
40	305										299										40
45	287	273									274	258									45
50	262	252									249	239									50
55	238	229	220								227	218	210								55
60	218	210	202	195							208	200	193	185							60
65	201	194	186	180	168	138					192	185	178	172	156						65
70	186	180	173	167	160	138					178	172	166	161	152						70
75	173	168	162	156	150	137	118				166	161	155	150	144	127	110				75
80	160	157	151	146	141	134	117	98			156	150	145	140	135	125	109	92			80
85	147	147	142	137	132	127	116	98	82.5		146	141	136	132	127	122	108	91.5	77.5		85
90	137	137	134	129	124	120	114	97.5	82.5		137	133	129	124	120	116	107	91	77.5		90
95	128	128	126	122	117	113	109	97	82	65	127	126	122	118	113	109	104	90.5	77	61.5	95
100		119	119	115	111	107	103	96	81.5	64.5		119	115	111	107	103	99	90.5	76.5	61	100
105		112	111	109	105	101	97.5	94.5	81	64		112	109	106	102	98	93.5	85.5	76	60.5	105
110		106	105	104	100	96.5	93	89.5	81	63.5		105	104	101	96.5	93	89	81.5	75.5	60.5	110
115		99.5	99	98	95.5	91.5	88	85	79.5	63.5		99	98.5	96	92	88.5	84.5	77.5	75	59.9	115
120			93.5	92.5	91	87.5	84	81	77	63			93	91.5	87.5	84.5	80.5	73.5	74	59.5	120
125			88.5	87.5	86.5	83	80	77	73.5	62.5			88	87.5	83.5	80.5	76.5	70.5	71	59	125
130			84	83	82	79.5	76.5	73.5	70	62			83.5	83	80	77	73	67	67.5	58.5	130
135				79.5	78	76	73	70	66.5	61				79	77	73.5	70	64	64.5	57.7	135
140				75.5	74.5	73	70	67	63.5	59.6				75.5	73.5	70.5	67	58.6	61.5	56.7	140
150				69	67.5	66.5	64	61	57.8	55.4				68.5	67.5	64.5	61	53.3	55.9	52.7	150
160					61.5	60.5	58.2	55.7	52.4	49.9					61.5	59.1	55.8	48.4	50.6	47.4	160
170					56.5	55.3	53.1	50.6	47.4	44.9					56.4	54.1	50.8	44.1	45.7	42.5	170
180					52.1	50.9	48.7	46.3	43	40.6					52	49.8	46.6	40.2	41.4	38.2	180
190						46.9	44.7	42.3	39.1	36.7						45.9	42.7	36.7	37.5	34.3	190
200							41.1	38.7	35.5	33.1							39.2	33.5	34	30.8	200
210							37.9	35.4	32.2	29.8							36	30.7	30.8	27.6	210
220							35.1	32.6	29.4	26.9							33.4	28.2	28	24.7	220
230								30	26.7	24.1								25.9	25.3	22	230
240								27.6	24.3	21.6									22.9	19.4	240
250									22	19.3									20.7	17	250
260									20	17.1									18.7	15	260
270										15.2										13.6	270
280										13.8										12.4	280

TAB 124125

Lifting capacities on SW boom/jib combination

Forces de levage en configuration SW

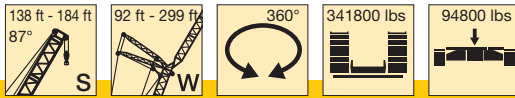

ft	138 ft										161 ft										184 ft						ft	
	92 ft	115 ft	138 ft	161 ft	184 ft	207 ft	230 ft	253 ft	276 ft	299 ft	92 ft	115 ft	138 ft	161 ft	184 ft	207 ft	230 ft	253 ft	276 ft	299 ft	92 ft	115 ft	138 ft	161 ft	184 ft	207 ft		230 ft
40	270																										40	
45	258	232																										45
50	237	223																										50
55	216	208	195																									55
60	199	191	184	168																								60
65	184	177	171	163	141																							65
70	171	165	159	153	140																							70
75	160	154	149	143	136	119																						75
80	150	144	139	134	129	118	101																					80
85	141	136	131	126	121	117	100	85.5	70.5																			85
90	133	128	124	119	115	110	99.5	85	70.5																			90
95	126	121	117	113	108	104	98	85	70.5	57.2																		95
100		115	111	107	103	99	95	84.5	70	57.1																		100
105		109	105	101	97	93.5	90	84	70	56.8																		105
110		104	100	96.5	92.5	89	85.5	81	69.5	56.5																		110
115		98.5	95.5	91.5	88	84.5	81.5	77.5	69.5	56.1																		115
120			91	87.5	84	80.5	77.5	74	68.5	55.7																		120
125			87	83.5	80	77	74	70.5	67.5	55.3																		125
130			83	80	76.5	73.5	70.5	67	64.5	54.9																		130
135			79.5	77	73.5	70.5	67.5	64	61.5	54.2																		135
140			75.5	74	70.5	67.5	64.5	61	58.6	53.6																		140
150				68	64.5	62	59	55.8	53.1	49.9																		150
160					59.5	56.7	53.9	50.7	47.9	44.5																		160
170					54.6	51.8	49	45.9	43.1	39.7																		170
180					50.5	47.6	44.8	41.7	38.9	35.6																		180
190						43.8	41	37.9	35.1	31.7																		190
200							37.6	34.4	31.7	28.2																		200
210							34.5	31.3	28.5	25																		210
220							31.9	28.6	25.7	22.1																		220
230								26.1	23.1	19.4																		230
240								23.9	20.7	16.8																		240
250									18.5	14.5																		250
260									16.4	13.2																		260
270										12																		270
280										10.9																		280

TAB 124125

Lifting heights on SW boom/jib combination
Hauteur de levage en configuration SW

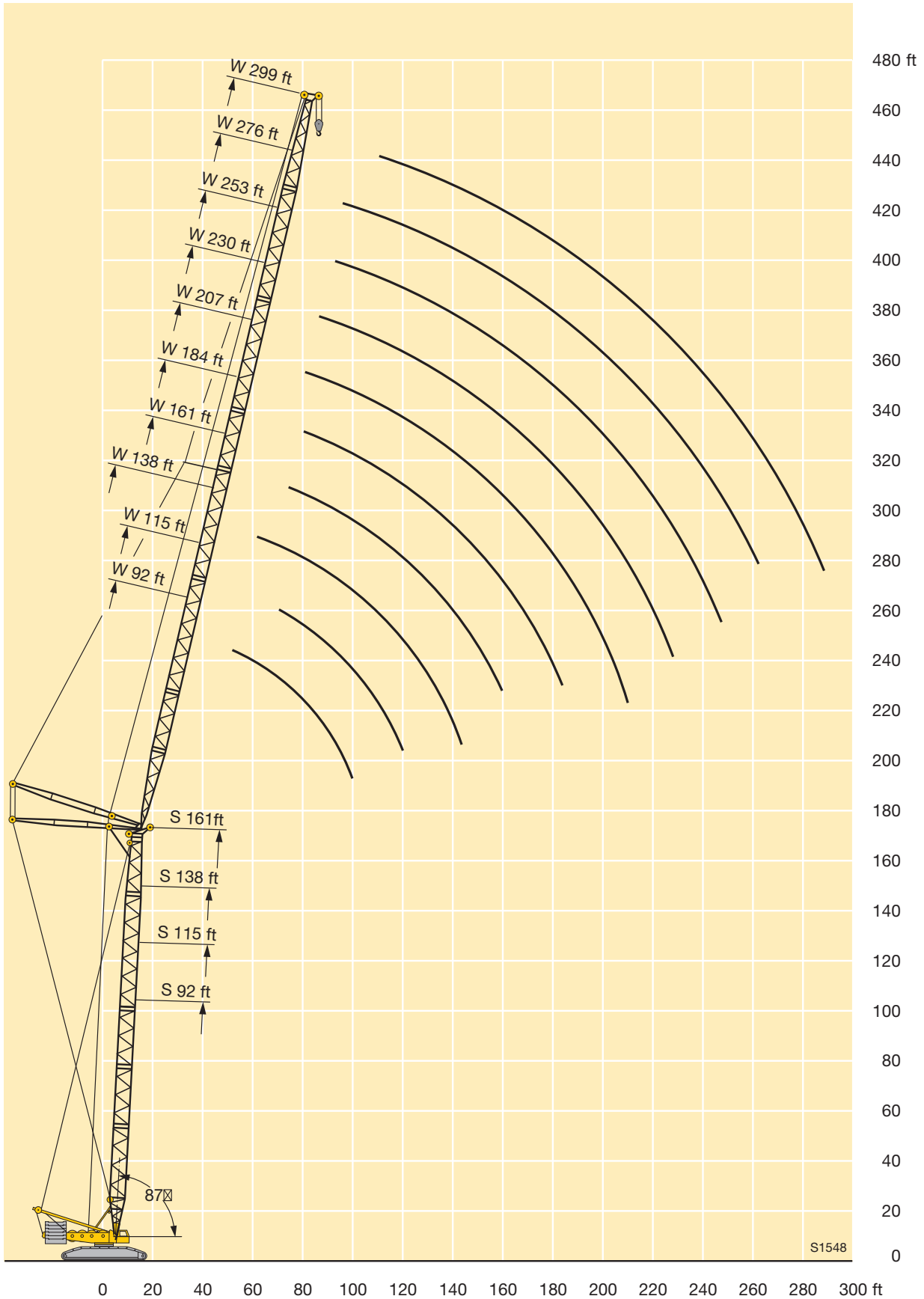

Lifting capacities on SDWB/BW boom/jib combination

Forces de levage en configuration SDWB/BW

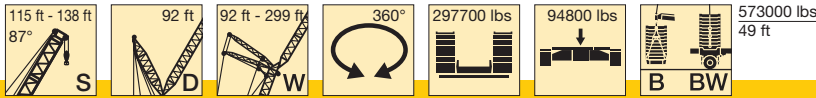

ft	115 ft										138 ft									ft	
	92 ft	115 ft	138 ft	161 ft	184 ft	207 ft	230 ft	253 ft	276 ft	299 ft	92 ft	115 ft	138 ft	161 ft	184 ft	207 ft	230 ft	253 ft	276 ft		299 ft
50	381										340										50
55	362	312	262								329	280									55
60	346	302	257	214							317	272	234	197							60
65	330	292	253	211							305	266	229	194							65
70	316	283	247	208	169						293	260	225	191	156						70
75	301	274	242	205	167	137					282	253	221	188	154	128					75
80	285	264	236	202	164	135	118				273	245	217	186	152	126	111				80
85	266	255	229	200	162	132	117				265	237	212	183	150	124	109				85
90	248	243	222	197	160	130	116	97	80		257	229	206	180	148	122	108	86.5			90
95	231	227	216	193	158	127	114	96	79.5	64	245	222	201	177	146	120	107	86	73	57.4	95
100		212	208	188	156	125	113	95.5	79	63.5		215	195	174	144	118	106	85	72.5	56.8	100
105		199	198	183	153	123	112	94.5	78.5	62.5		210	190	170	141	117	105	84	72	56.2	105
110		188	187	179	149	121	111	94	78	62		201	185	166	138	115	104	83.5	71	55.7	110
115		178	177	173	146	119	109	93.5	77.5	61.5		189	182	162	135	113	103	82.5	70.5	55.1	115
120		167	169	166	142	116	108	92.5	77	60.5		174	177	159	133	110	102	82	70	54.5	120
125			161	157	139	113	106	92	77	60			172	155	130	108	100	81	69.5	53.8	125
130			153	150	136	110	105	91	76.5	59.4			164	152	128	105	99	80.5	69	53.2	130
135			146	144	133	107	103	90.5	76	58.8			155	148	125	102	98	79.5	68.5	52.5	135
140			138	138	130	104	102	89.5	76	58.1			146	145	122	100	96.5	78.5	68	51.8	140
150				126	122	98.5	99.5	88.5	75	56.8				135	118	95.5	94.5	77	67	50.4	150
160					113	93.5	97	87	74.5	55.5					114	91	92	76	65.5	49	160
170					105	89	94.5	85.5	73	54.2					111	87	90	74.5	64.5	47.8	170
180					97	85	91	84.5	72	53.1					102	83	88	71	64	46.6	180
190						81.5	86	81.5	71	52						80	84.5	67.5	61.5	45.4	190
200						78	80.5	77	70	51						76.5	80.5	63.5	58.7	44.3	200
210							75	72	68.5	50							77.5	59.9	55.4	43.2	210
220							69.5	67.5	65.5	49							73.5	56.5	52.3	42.2	220
230								63	61.5	48.2								53.2	49.3	41.2	230
240								58.5	57.5	47.3								50	46.4	40	240
250									53.7	46.4									43.6	38.5	250
260									50.1	45.6									41	36.1	260
270									46.6	43.2									38.2	34	270
280										40.4										32	280

TAB 124118 / 124121

Lifting capacities on SDWB/BW boom/jib combination

Forces de levage en configuration SDWB/BW

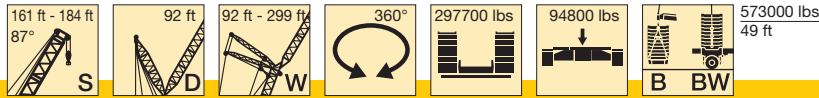

ft	161 ft										184 ft										ft	
	92 ft	115 ft	138 ft	161 ft	184 ft	207 ft	230 ft	253 ft	276 ft	299 ft	92 ft	115 ft	138 ft	161 ft	184 ft	207 ft	230 ft	253 ft	276 ft	299 ft		
50	295										262											50
55	286	247									254	219										55
60	278	241	209								246	214	186									60
65	269	235	204								238	209	182									65
70	260	230	200	173	146						230	204	178	155								70
75	251	224	196	171	144	119					222	199	174	152	132							75
80	243	218	192	168	142	117	101				215	194	170	149	130	107	92					80
85	235	211	188	166	141	116	100				209	188	166	146	128	105	90.5					85
90	229	205	183	163	139	114	99	81.5			204	183	162	144	126	103	89	75.5				90
95	224	199	178	160	137	113	98	80.5	68		202	177	158	141	125	101	88	74.5	62.5			95
100	215	194	174	156	135	111	97	80	67.5	50.1	200	173	154	139	123	100	87	74	62	46.2	100	
105		190	169	152	133	110	96	79	67	49.5		170	150	136	121	98.5	85.5	73	61.5	45.6	105	
110		187	166	149	131	108	95	78.5	66.5	48.9		168	146	133	119	97	84.5	72.5	61	45	110	
115		183	162	145	128	106	93.5	77.5	66	48.3		166	143	130	116	95.5	83.5	72	60.5	44.5	115	
120		175	159	142	126	104	92.5	77	65.5	47.7		164	141	128	114	93.5	83	71	60	44	120	
125			156	139	123	102	91	76.5	64.5	47.2			139	125	112	91.5	82	70.5	59.5	43.5	125	
130			153	136	121	99.5	90	75.5	64.5	46.7			137	122	110	89.5	80.5	70	59	43	130	
135			149	133	119	97.5	88.5	74.5	63.5	46.1			135	121	108	87.5	79.5	69	58.5	42.5	135	
140			143	129	117	95.5	87	74	63	45.4			132	119	106	86	78	68.5	58.1	41.9	140	
150				125	113	91	84	72.5	62	43.9				116	102	82.5	75	66.5	57	40.8	150	
160				118	109	87.5	80.5	70.5	61	42.4				111	98.5	79	72	64.5	55.8	39.5	160	
170				101	104	84	76	68.5	59.9	41.1				103	94	76	69	62.5	54	38.2	170	
180					99.5	81	72	65	58.7	39.8					90	72.5	65	60	52.3	37	180	
190						77.5	68.5	61.5	56.4	38.5						68.5	61	57.3	50.6	35.9	190	
200						75	65	58.1	53.5	37.6						65	58.1	54	48.5	34.9	200	
210							61.5	54.8	50.5	37.1							55.4	50.9	45.6	34.1	210	
220							58.5	51.7	47.7	36.7							52.6	48.1	43	33	220	
230								48.7	44.9	35.4							49.9	45.3	40.5	31.1	230	
240								45.7	42.3	33.8								42.5	38.2	29.2	240	
250									39.8	32.2									35.9	27.7	250	
260									37.4	30.7									33.6	26.6	260	
270									34.7	29.3									31.3	25.5	270	
280										27.9										24.4	280	
290										26.4										23.2	290	
300										24.8										22	300	

TAB 124118 / 124121

Lifting capacities on SDWB/BW boom/jib combination

Forces de levage en configuration SDWB/BW

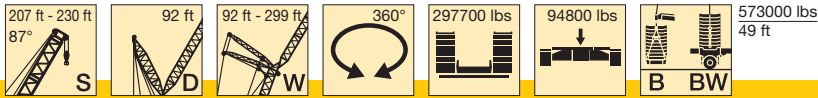

ft	207 ft										230 ft									ft		
	92 ft	115 ft	138 ft	161 ft	184 ft	207 ft	230 ft	253 ft	276 ft	299 ft	92 ft	115 ft	138 ft	161 ft	184 ft	207 ft	230 ft	253 ft	276 ft		299 ft	
55	222	195									195	115	138	161	184	207	230	253	276	299	55	
60	215	190	166								189	167									60	
65	209	186	163								184	163									65	
70	202	181	159	138							179	160	141	124							70	
75	196	177	156	136	118						174	157	138	121	105						75	
80	190	172	153	133	116	96.5					169	153	135	119	104	86.5					80	
85	185	167	150	131	115	95					164	148	132	117	102	85					85	
90	182	162	146	129	113	93.5	82.5				161	144	128	115	100	83.5	73.5				90	
95	181	158	142	127	112	92	81.5	68.5	56.9		160	141	125	113	99	82.5	72.5	62			95	
100	181	154	139	124	110	91	80.5	68	56.4	41.9	159	137	122	111	97.5	81	71	61	50.7	38.3	100	
105		151	135	122	108	89.5	79.5	67	55.9	41.3		134	119	108	96	80	70	60	50.2	37.7	105	
110		150	132	119	106	88.5	78.5	66.5	55.5	40.7		133	117	106	93.5	78.5	69	59.4	49.7	37.1	110	
115		148	130	117	104	87	77.5	65.5	55.1	40.2		131	115	103	91.5	77.5	68	58.6	49	36.5	115	
120		146	128	114	102	85.5	76.5	65	54.6	39.7		130	113	101	89.5	76	67	57.9	48.3	36	120	
125			126	112	100	83.5	75	64	54	39.2			111	98.5	88	74.5	66	57.1	47.7	35.4	125	
130			124	110	98	82	73	63.5	53.4	38.7			109	96.5	86	72.5	65	56.4	47	35	130	
135			122	107	96	80	72	62.5	52.8	38.2			108	95	84.5	71	64	55.5	46.4	34.5	135	
140			120	105	94	78.5	70.5	61.5	52.2	37.8			106	93.5	82.5	69.5	63	54.6	45.8	34	140	
150				102	91	75.5	67.5	59.5	51.1	36.8				91.5	80	66.5	60.5	52.5	44.6	33.2	150	
160				99.5	88	72.5	65	57.3	49.9	35.8				89.5	78.5	64	57.8	50.4	43.4	32.3	160	
170				97.5	85	69.5	63	55.3	48.4	34.8				87.5	77	62	55.4	48.3	41.9	31.5	170	
180					81	66	60	53.4	46.6	33.7					76	59	53.1	46.3	40.1	30.6	180	
190						62.5	57.1	51.2	44.8	32.7					74.5	55.9	50.8	44.4	38.4	29.6	190	
200						58.8	54.1	48.7	42.9	31.7						52.9	48.4	42.6	36.7	28.5	200	
210							51.3	46.1	41.1	30.8							45.9	41	35.1	27.4	210	
220							48.6	43.9	38.5	30							43.5	38.8	33.6	26.3	220	
230							46.1	41.5	36.2	28.8							41.2	36.7	31.7	25.4	230	
240								39.3	34	27.6								34.7	29.8	24.5	240	
250									31.9	26.3									32.8	27.9	23.3	250
260									29.9	25.2									30.9	26.1	22	260
270									27.9	23.9										24.4	20.8	270
280										22.7											19.7	280
290										21.5											18.5	290
300										20.3											17.4	300

TAB 124118 / 124121

Lifting capacities on SDWB/BW boom/jib combination

Forces de levage en configuration SDWB/BW

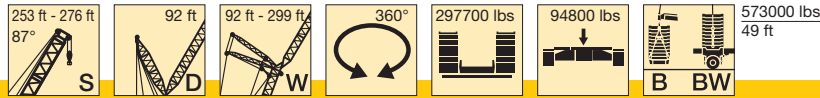

ft	253 ft										276 ft							ft	
	92 ft	115 ft	138 ft	161 ft	184 ft	207 ft	230 ft	253 ft	276 ft	299 ft	115 ft	138 ft	161 ft	184 ft	207 ft	230 ft	253 ft		276 ft
55	173																		55
60	168	148									130								60
65	163	144									127								65
70	159	141	125								124	108							70
75	154	138	123	107	93						121	106	93.5						75
80	151	135	120	105	91	77					118	104	91.5	80.5					80
85	148	131	117	103	89.5	75.5					114	101	89.5	79					85
90	145	127	114	101	88	74	64.5				111	98.5	87.5	77.5	67	57.8			90
95	142	123	111	99	86.5	73	63.5	54.1			108	96	85.5	76	66	56.7	49		95
100	139	120	108	96.5	85	71.5	63	53.1	44.8		105	94	83.5	74.5	65	55.7	48.2	39.9	100
105		118	106	94.5	83	70.5	62	52.2	44	33.6	103	91.5	82	73	64	54.7	47.4	39.1	105
110		116	103	92	81.5	69.5	61	51.4	43.2	33.1	101	89.5	80.5	72	63	53.8	46.7	38.4	110
115		114	101	90	79.5	68.5	60	50.6	42.5	32.6	99.5	88	78.5	70	61.5	52.9	46	37.7	115
120		113	98.5	88	77.5	67	59.1	49.8	41.9	32.1	98.5	86	77	68.5	60	52	45.4	36.8	120
125			97	86.5	76	65.5	57.6	49	41.2	31.5	97	84.5	75.5	67	58.7	51.2	44.7	35.5	125
130			95.5	85	74	64	56.3	48.3	40.6	30.3	95.5	83.5	74	65.5	57.4	50.4	44.1	34.2	130
135			94	83.5	72.5	62.5	55	47.4	40	29.2		82	73	64	56.2	49.4	43.4	33	135
140			92.5	82.5	71	61	53.8	46.5	39.4	28.2		80.5	71.5	62.5	55	48.5	42.6	31.8	140
150				80	68.5	58.5	51.5	44.6	38.1	26.3			69	60	52.8	46.4	40.9	29.8	150
160				78	67	56.1	49.2	42.6	36.7	24.7			67	58.1	50.9	44.2	39.2	28.3	160
170				75.5	65.5	54	47.1	40.8	35.1	23.4			65.5	56.6	49.2	42.3	37.6	27.2	170
180				64	52.3	45.4	39.1	33.6	22.3					55.2	47.6	40.4	35.4	26.3	180
190				63	50.3	43.8	37.5	32.1	21.4					54	46.1	38.9	33.4	25.4	190
200					48.1	42.4	36	30.6	20.6						44.7	37.6	31.9	24.6	200
210						40.8	34.7	29.3	19.9							36.6	30.8	23.8	210
220						38.5	33.7	28.2	19.5							35.6	30.5	23.3	220
230						36.4	32.1	27.2	19.3						34.7	29.9	22.9	22.9	230
240							30.3	26	19.1							29.2	22.5	22.5	240
250							28.6	24.3	18.9							28.4	22.1	22.1	250
260							27.1	22.7	18.8							26.8	21.8	21.8	260
270								21.1	17.9								20.8	20.8	270
280									16.8								19.5	19.5	280
290									15.8										290
300									14.8										300

TAB 124118 / 124121

Lifting heights on SDWB/BW boom/derrick/jib combination
Hauteur de levage en configuration SDWB/BW

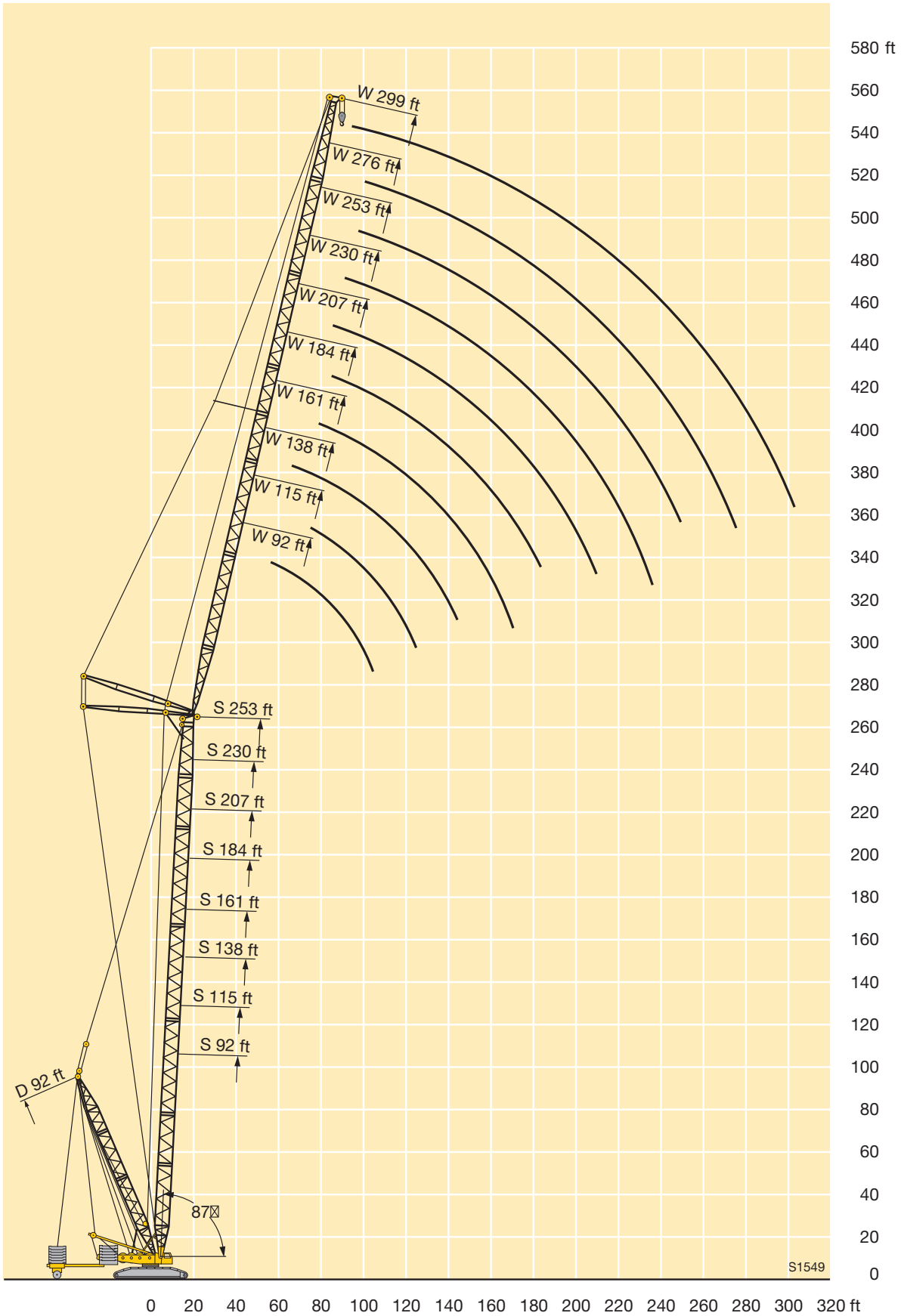

Lifting capacities on SDWB/BW boom/jib combination

Forces de levage en configuration SDWB/BW

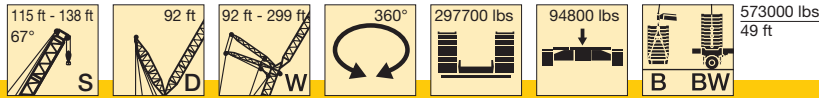

ft	115 ft										138 ft									ft			
	92 ft	115 ft	138 ft	161 ft	184 ft	207 ft	230 ft	253 ft	276 ft	299 ft	92 ft	115 ft	138 ft	161 ft	184 ft	207 ft	230 ft	253 ft	276 ft		299 ft		
110	224																					110	
115	218																						115
120	211										206												120
125	205	200									199												125
130	199	194									193	186											130
135	194	188									188	182											135
140	190	183	173								182	177	166										140
150		173	167									167	161										150
160			157	150								158	152	147									160
170			147	142	132							152	145	140	126								170
180			138	134	127								138	133	125								180
190				125	121	97							133	127	122	95							190
200				115	113	94	93							122	117	93.5	87						200
210					104	91	93	74							112	92	87	67.5					210
220					97	86.5	90.5	74	59.7						107	88.5	87	67.5	54.8				220
230					90.5	83	85.5	74	60						101	85	87	67.5	54.9				230
240						79.5	79.5	73	60	43.3						81.5	86	67.5	54.9	39.6			240
250							74	71	60	43.3						79	84	67.5	54.9	39.6			250
260							69	66.5	60	43.3						78.5	78	67.5	54.9	39.6			260
270							65	61.5	59.1	43.3							73.5	67.5	54.9	39.6			270
280								57.7	56.7	43.3							69	65.5	54.9	39.6			280
290								54.4	52.7	43.3								61.5	54.9	39.6			290
300								51.4	49.1	43.3								58.1	54.9	39.6			300
310									46.2	42									52.7	39.6			310
320									43.6	40									49.9	39.6			320
330										37.7										39.6			330
340										35.5										39.6			340
350																				38.3			350

TAB 124143 / 124140

ft	161 ft										184 ft									ft			
	92 ft	115 ft	138 ft	161 ft	184 ft	207 ft	230 ft	253 ft	276 ft	299 ft	92 ft	115 ft	138 ft	161 ft	184 ft	207 ft	230 ft	253 ft	276 ft		299 ft		
130	183																						130
135	179																						135
140	174	164										161											140
150	165	159										156											150
160		150	146									148	144										160
170		143	138	134								142	137	132									170
180		138	132	128									130	126									180
190			126	122	116									120	117								190
200				117	112	90.5								116	112	107							200
210				112	108	90	82								107	102	86						210
220				109	104	89	82	63							103	98.5	85.5	77					220
230					100	86	82	63.5							100	95	85	77.5					230
240					97	83	82	63.5	51.4							92	83.5	77.5	59.8				240
250						80	82	63.5	51.4	36.8						89	80.5	77	59.8	47.9			250
260						78.5	79	63.5	51.4	36.8						87.5	78	75	59.8	47.9	34		260
270						77.5	76.5	63.5	51.4	36.8							77	72.5	59.8	47.9	34.1		270
280							74	63.5	51.4	36.8								70.5	59.8	47.9	34.1		280
290								63.5	51.4	36.8								68.5	59.8	47.9	34.1		290
300								63.5	51.4	36.8								67.5	59.8	47.9	34.1		300
310								60.5	51.4	36.8									59.4	47.9	34.1		310
320									51.4	36.8									58.5	47.9	34.1		320
330									50.9	36.8										47.9	34.1		330
340									48.1	36.8										47.9	34.1		340
350										36.8										46.3	34.1		350
360										36.8											34.1		360

TAB 124143 / 124140

Lifting capacities on SDWB/BW boom/jib combination

Forces de levage en configuration SDWB/BW

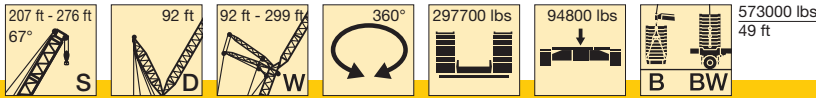

ft	207 ft									230 ft									ft	
	115 ft	138 ft	161 ft	184 ft	207 ft	230 ft	253 ft	276 ft	299 ft	92 ft	115 ft	138 ft	161 ft	184 ft	207 ft	230 ft	253 ft	276 ft		299 ft
160										134										160
170	130									128	123									170
180	124									122	118									180
190	119	115									113	108								190
200		110	106								108	104	99.5							200
210		105	101	96								99.5	95	86						210
220		102	97.5	93	80.5	70						95.5	91.5	84.5	71					220
230			94	89.5	80.5	70							88	83	71					230
240				86.5	80	70	53.8						85.5	81	71	59.5				240
250				83.5	78.5	70	53.8	43.2						78	70.5	59.5	47.8			250
260				81.5	76	69	53.8	43.2	30.8					75.5	68.5	59.5	47.8	38		260
270					74	67.5	53.8	43.2	30.9					74	66.5	59.5	47.8	38		270
280					72	65.5	53.8	43.2	30.9						65	58.8	47.8	38	28.1	280
290						64	53.8	43.2	30.9						63.5	57.3	47.8	38	28.1	290
300						62.5	53.8	43.2	30.9						63	55.8	47.8	38	28.1	300
310						61.5	53.8	43.2	30.9							54.8	47.6	38	28.1	310
320							53.4	43.2	30.9								47	38	28.1	320
330								43.2	30.9								46.2	38	28.1	330
340								43.2	30.9								45.8	38	28.1	340
350								43.2	30.9									38	28.1	350
360									30.9									38	28.1	360
370									30.9										28.1	370
380									30.9										28.1	380
390									30.9										28.1	390

TAB 124143 / 124140

ft	253 ft									276 ft								ft		
	92 ft	115 ft	138 ft	161 ft	184 ft	207 ft	230 ft	253 ft	276 ft	299 ft*	115 ft	138 ft	161 ft	184 ft	207 ft	230 ft	253 ft		276 ft*	
170	120																			170
180	114																			180
190	110	105																		190
200		101	94.5																	200
210			92.5	81.5							83									210
220			89	80.5	68						80.5	70								220
230			86	78.5	67.5						78	68	60							230
240				76.5	66.5	56.9						65.5	58.9							240
250				74	65.5	56.6	47					64	57.2	49.2						250
260				73.5	63.5	56.2	46.8	37.4					55	48	40.3					260
270					62	55	46.7	37.4					53.2	46.3	39.3	31.7				270
280					61	53.5	46.2	37.4	29				52.7	44.5	38.2	31.1				280
290						52	45.2	37.3	29	23.3					35.4	29.5	25.3	20.6		290
300						51.6	43.9	36.8	29	23.3					34.1	28.5	24.9	20.2		300
310							42.9	36	29	23.3					33.9	27.6	24.2	19.9		310
320							42.4	35.1	28.8	23.3						26.9	23.4	19.4		320
330								34.3	28.3	23.3						26.6	22.6	18.9		330
340								34	27.8	23.3						26.6	21.9	18.3		340
350								34	27.2	22.9							21.8	17.7		350
360									27	22.5							21.7	17.2		360
370									27	22.2								17		370
380									27	22								17		380
390										22										390

* only with ballast trailer / seulement avec porteur de lest

TAB 124143 / 124140

Lifting heights on SDWB/BW boom/derrick/jib combination
Hauteur de levage en configuration SDWB/BW

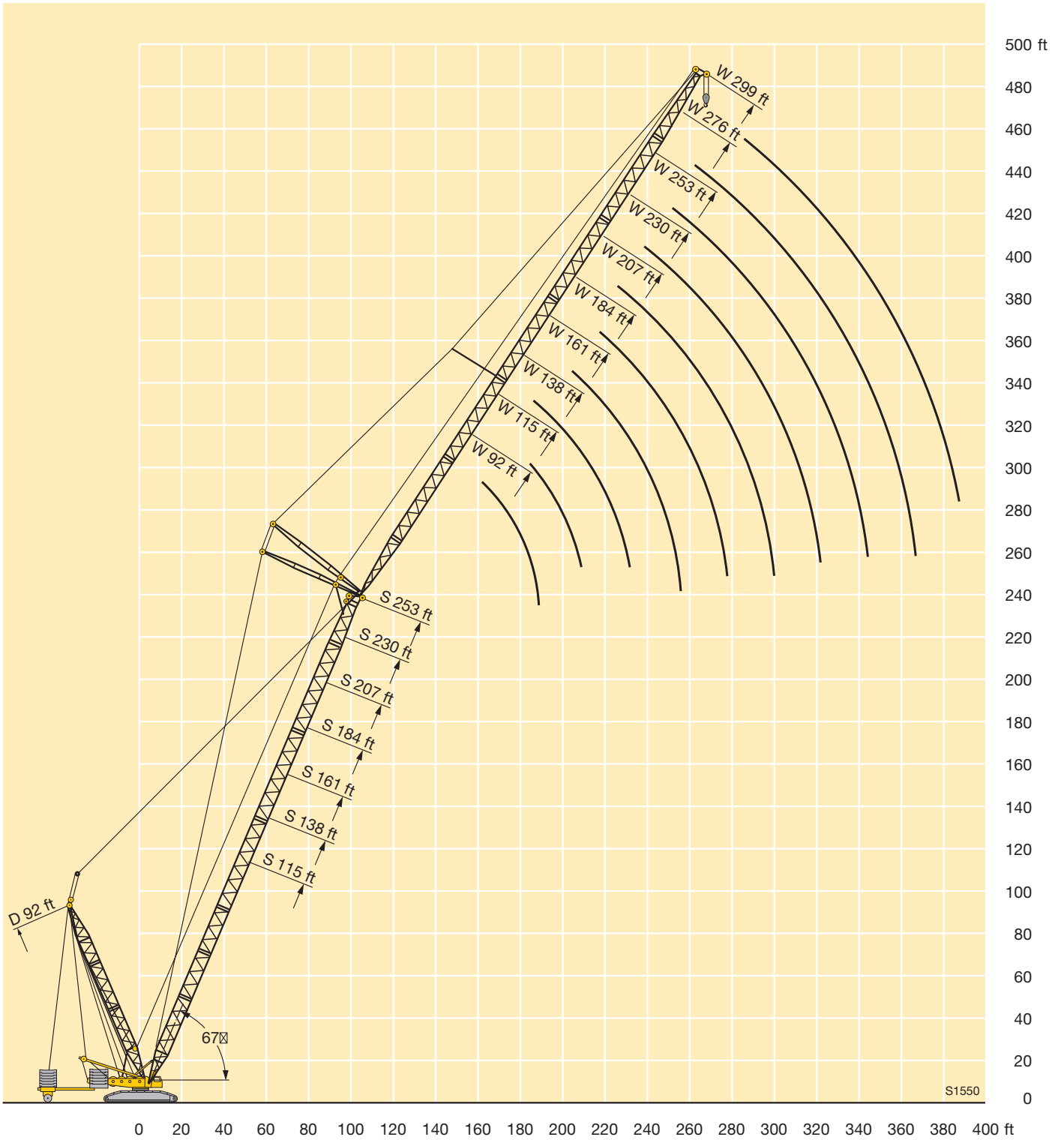

Liebherr-Werk Ehingen GmbH

Postfach 1361, 89582 Ehingen, Germany

☎ +49 73 91 5 02-0, Fax +49 73 91 5 02-33 99

www.liebherr.com, E-mail: info.lwe@liebherr.com